

## *Lecture 8*

# Smartcards and Related Application Infrastructures



Mobile Business I (WS 2023/24)

Prof. Dr. Kai Rannenber

Chair of Mobile Business & Multilateral Security  
Goethe University Frankfurt a. M.

- Smartcards – Introduction
- Subscriber Identity Module (SIM)
- WAP Identity Module (WIM)
- Universal SIM (USIM) and UICC
- IP Multimedia Services Identity Module (ISIM)
- Apple SIM
- Google Fi Project
- eSIM
- New Applications – CamWebSIM

- Small computers with **memory, operating system, software, processor, I/O and access control**
- **Chip protected against manipulation**
- After being **initialised with keys** and other data smartcards are distributed to their users.

- Used when **security** of data (e.g. for keys, signatures, physical access control, payment) is needed in **insecure environments**
- **Examples:**
  - Phone cards of Deutsche Telekom
  - Signature cards according to German Signature Law
  - Smartcard applications for PC
  - Smartcards for mobile communication (SIMs)



## Smartcards – Examples

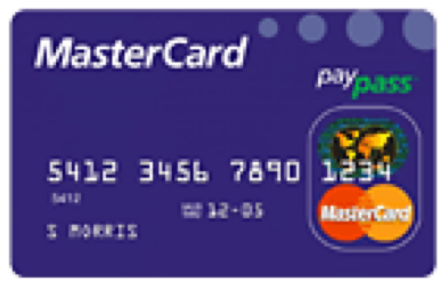

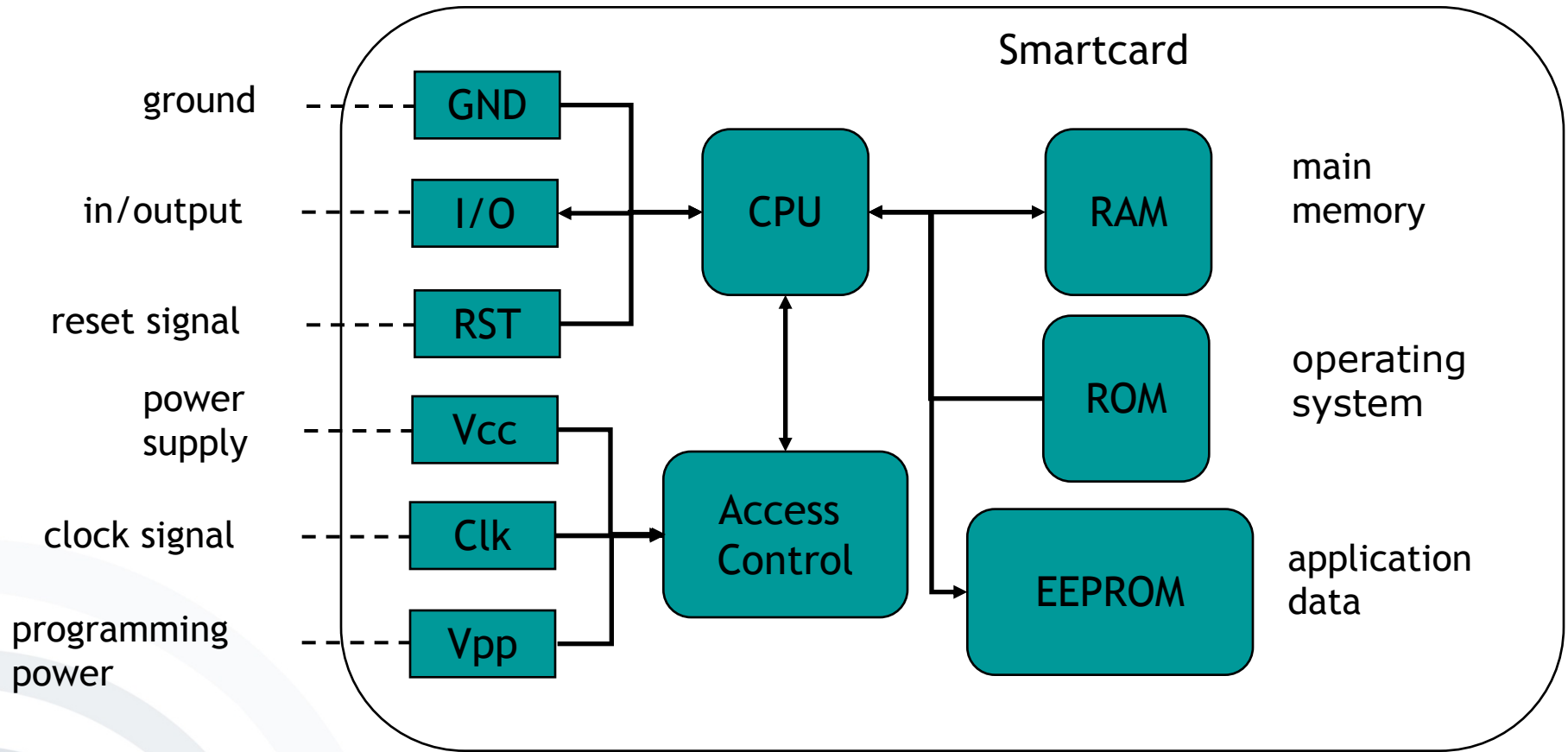

[Source: SecCommerce2013]

## Protection needed against:

- Unauthorised usage of services through forged user data
- Duplication of a user's credentials
- „Cracking“ of credentials
- Billing fraud

## CELLULAR COUNTERFEITING/CLONING FRAUD

### Cellular Phone Counterfeiting

With each call made, a cellular phone transmits an Electronic Serial Number (ESN) and a Mobile Identification Number (MIN) identifying the caller. Possession of these numbers is the key to the counterfeiting.

Example for faulty system design (CDMA)

Duplication of intercepted user IDs

CDMA2000 overcame this by introducing the CSIM.

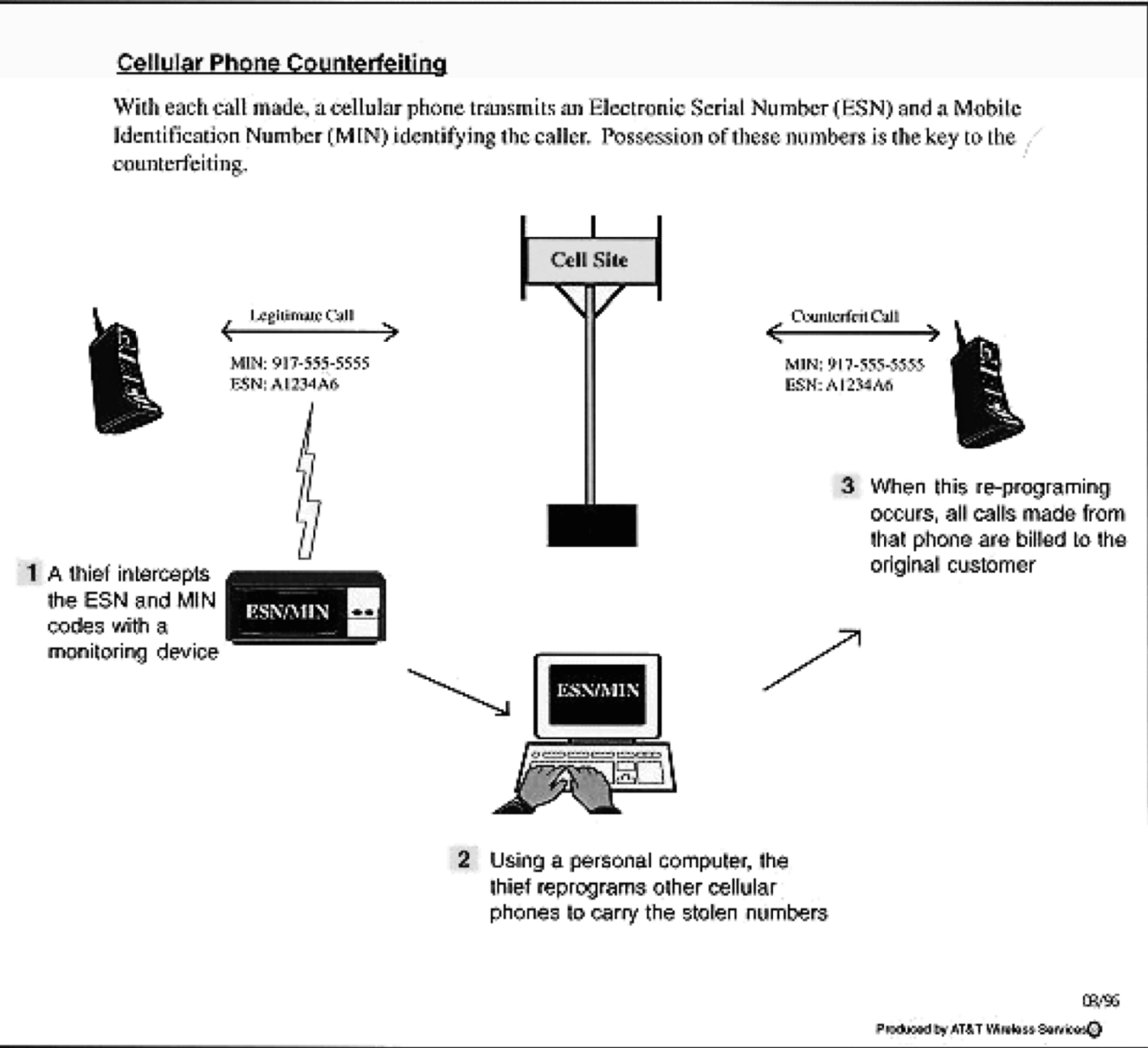

- Smartcards – Introduction
- Subscriber Identity Module (SIM)
  - Functionality
  - Technology
  - SIM Application Toolkit (SAT)
- WAP Identity Module (WIM)
- Universal SIM (USIM) and UICC
- IP Multimedia Services Identity Module (ISIM)
- Apple SIM
- Google Fi Project
- eSIM
- Applications – CamWebSIM

## The Subscriber Identity Module (SIM)

- In GSM since 1991, and used in all further mobile networks
- **Represents contract between subscriber & network operator**
- Authorises a “phone” to use the network by linking it to a **subscription**
- By 2021 around **5.3 billion** mobile broadband subscribers (forecast to grow to **5.7 billion** by 2025) with **\$1.08 trillion** mobile operator revenue (forecast to grow to **\$1.16 trillion** by 2025) [GSMA2022]
- More countries with SIM infrastructure (ca. 240, 2019-Q2) than McDonalds (117, 2022) and UN-members (193, 2022) [GSMA2019, McDonalds2022, Wiki2022, UN2022]
- More and more called “Subscriber **Identification Module**” to reflect progress in the general field of **Identity Management**



- **SIMs are Smartcards:**
  - SIM cards serve as security medium.
  - Tamper-resistance prevents counterfeiting.
  - robust design
- Contain **International Mobile Subscriber Identity (IMSI)** for subscriber identification and the key  $K_i$  provided by the mobile operator
- Reliably execute computational functions for the mobile device



- SIM serves as „**identity card**“ for GSM cellular phone subscribers.
- SIM identifies the **issuer of the card** – important for the **billing of roaming subscribers** by roaming partner.
- SIM allows for **secure billing of roaming subscribers** through SIM-cryptography – important for card issuer.
- SIM contains additional **configuration data** of the GSM system.



- (Rather) static data:
  - IMSI, PIN, PUK
  - A3, A8 crypto algorithms
  - List of allocated (subscribed) services
  - Language preferred by the subscriber
- Dynamic data:
  - Cell information
  - Frequency information
  - Dynamically generated (session) keys
  - Attributes of GSM login
  - User data (address book, telephone list, SMS memory)

# Integration into Mobile Phones

- **ETSI GSM 11.11** [GSM2006] specifies electrical as well as software interfaces between SIM and device.
  - A **serial interface** is used for accessing the card.
  - Communication through **SIM commands**
  - Device can access **files** or execute **actions** through SIM commands.
  - „SIM Application Toolkit“ allows for implementing of **additional applications** on a SIM.
- Meanwhile SIMs are available in different **form factors**
  - Same size as 'regular' smart cards (Full-size, FF).
  - Mini-SIM (2FF) introduced circa 1996
  - Micro-SIM (3FF) introduced in 2010
  - Nano-SIM (4FF) introduced in 2012

- Provides an interface for **Value Added Services** implemented on **programmable SIMs** for interacting with mobile devices
- **Standardised 1996** as ETSI GSM 11.14, extended 1999 [GSM2006]
- **Controls I/O, Telephony, Download**
- Allows for **security functionality**
- „Living standard“

- **Mobile Banking and Brokerage**
  - T-Mobile and T-Online SMS banking
- **Secure payment** via cellular phone
- **Authentication** of users trying to access servers
- **Location-based services**
  - ATM search, navigation
- **Security applications in general**
  - Mobile signatures

- Smartcards – Introduction
- Subscriber Identity Module (SIM)
- WAP Identity Module (WIM)
- Universal SIM (USIM) and UICC
- IP Multimedia Services Identity Module (ISIM)
- Apple SIM
- Google Fi Project
- eSIM
- Applications – CamWebSIM

- **WAP** is a protocol family implementation of Client/Server applications on mobile devices.
- Originally WAP did not provide sufficient **end-to-end security** for applications.
- The **WAP Identity Module (WIM)** should solve security problems raised by WAP.
- **WIM** is implemented as an **additional application** on a SIM.
- More and more called “**Wireless Identification Module**” to reflect progress in the general field of **Identity Management**

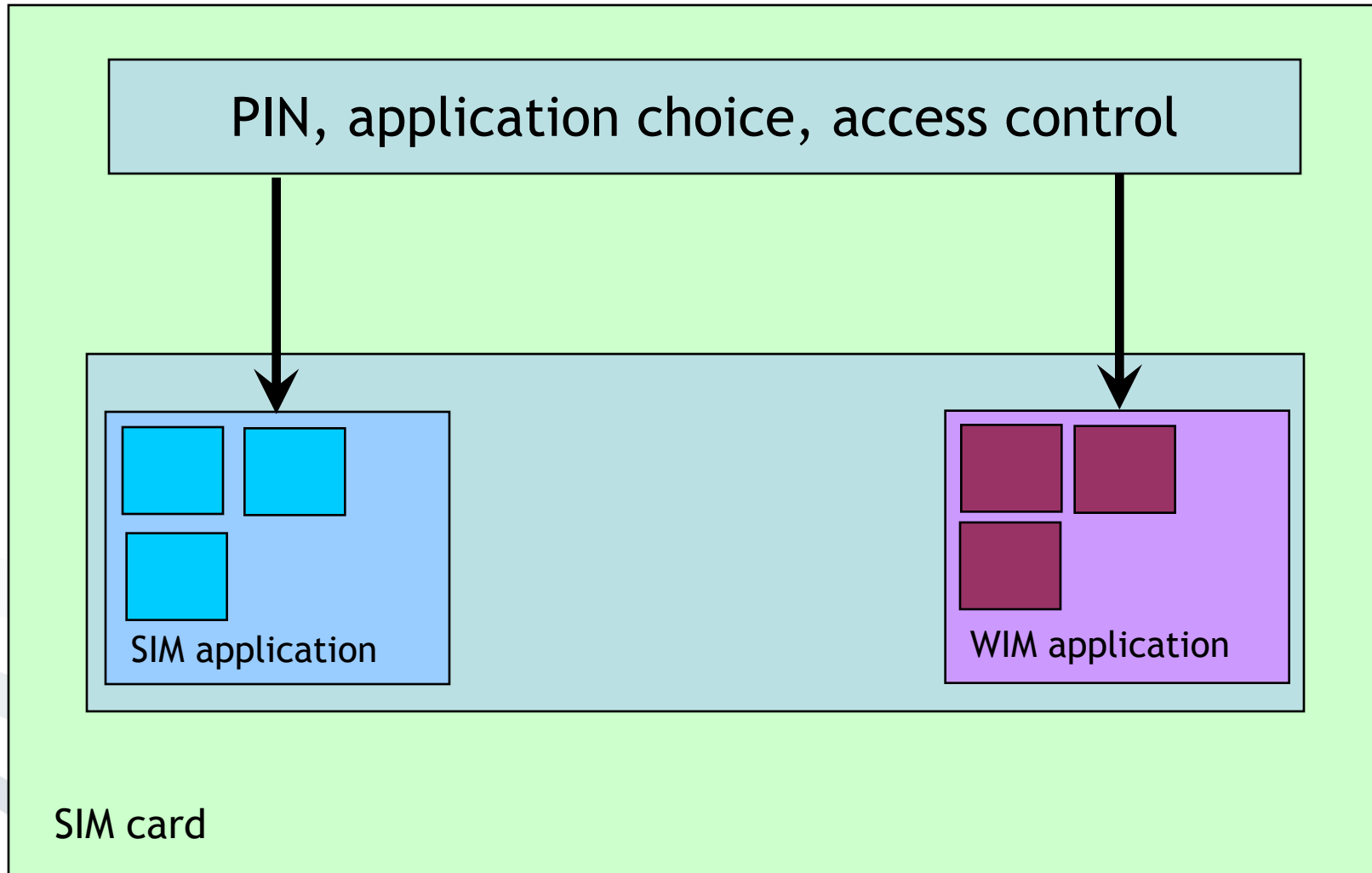

- **Secure storage** for keys and certificates
- **Tamper resistance** of SIM based crypto algorithms
- **Standardised interface** to security functions (PKCS#15)
- **RSA signatures** are implemented on WIM



- Not in widespread use
- Many demonstrations, including signature applications
- Smartcard manufacturers provide WIM as an option for SIMs (e.g. Giesecke & Devrient's StarSIM®).
- Till now no WIM has been certified as signature creation device as required by German "Signaturgesetz" (SigG).

- Smartcards – Introduction
- Subscriber Identity Module (SIM)
- WAP Identity Module (WIM)
- Universal SIM (USIM) and UICC
- IP Multimedia Services Identity Module (ISIM)
- Apple SIM
- Google Fi Project
- eSIM
- Applications – CamWebSIM

- **Standardised** in 3GPP TS 21.111 and 3GPP TS 31.102 [GSM2006]
- **Successor** of SIM in 3G networks (but 3G networks are downward compatible to many SIMs)
- Supports different „virtual“ **USIMs** and **SIMs** on one card – i.e. multifunctional smartcard
- Specified as „**UMTS-SIM**“, to support authentication, authorisation and computation of future services

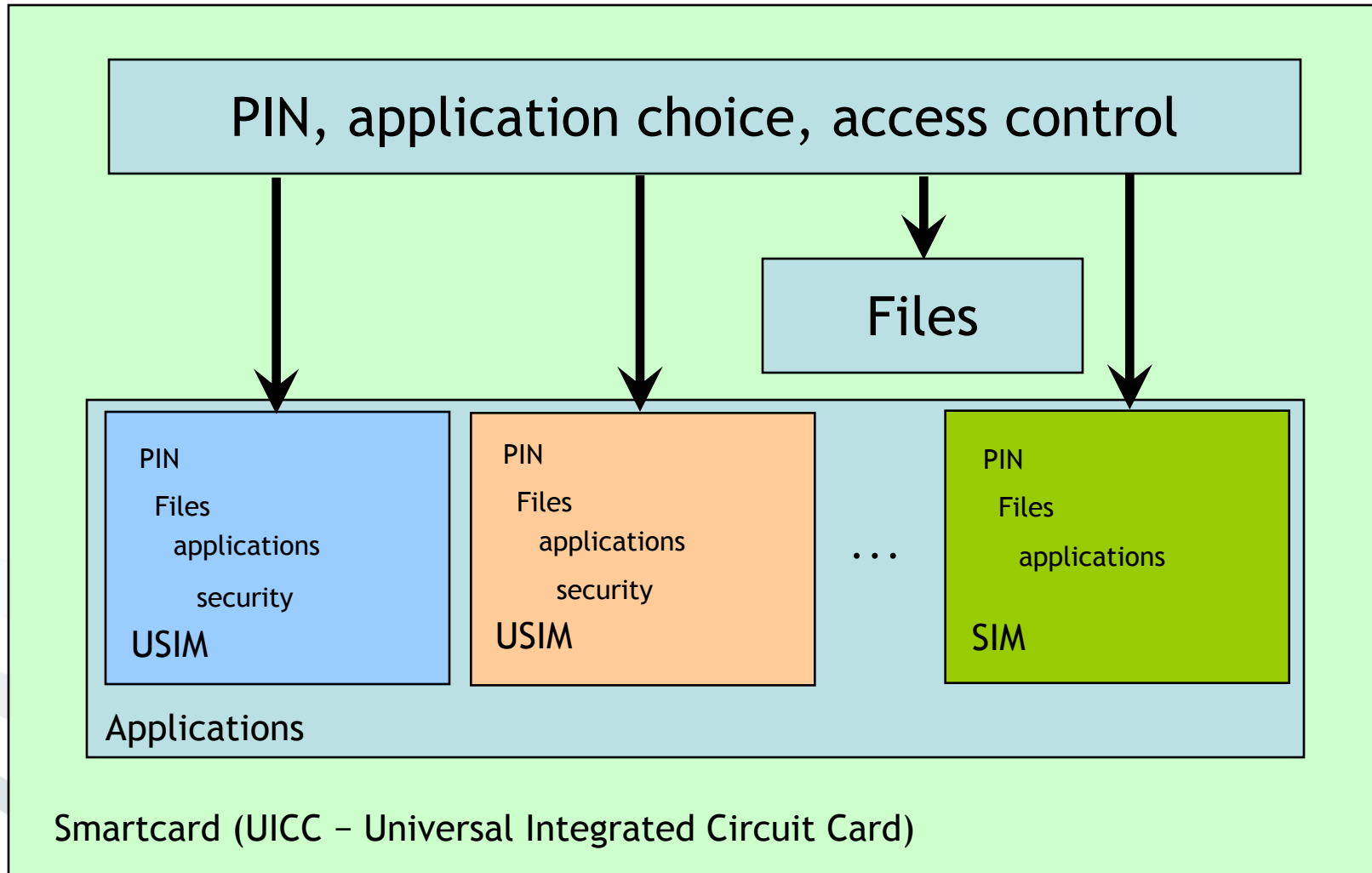

- **Support for multiple applications**
- **End-to-end security** from the USIM to the application
- **Authentication of the network** towards the USIM via cryptography
  - ➔ **Multilateral Security** is possible!
- **Downward compatible** to SIM
- **Extended phone book** on card:
  - Email addresses
  - Multiple names & numbers for each entry
  - More memory
  - Standardised entries

## Visions of new Opportunities

- **Market entry of USIM „disguised“ as SIM**
  - ➔ UMTS activated by operator
- **Multiple USIMs – possibly from competing providers – can technically coexist on one card. Selection via menu on mobile device**
  - ➔ Reduction of operator switching cost
- **Switching to anonymous prepaid USIM as a privacy option when using privacy sensitive services?**

- Secure Elements (SE) are hardware tokens, that offer secure services, e.g. tamper-proof storage and cryptographic operations (cf. Lecture 12).
- UICCs are one form factor of a Secure Element (SE), enabling secure mobile applications and services.



[DTAG2014]

- Smartcards – Introduction
- Subscriber Identity Module (SIM)
- WAP Identity Module (WIM)
- Universal SIM (USIM) and UICC
- IP Multimedia Services Identity Module (ISIM)
- Apple SIM
- Google Fi Project
- eSIM
- Applications – CamWebSIM



- An **IP Multimedia Services Identity Module (ISIM)** is an application running on a UICC smart card in a 3G mobile telephone in the IP Multimedia Subsystem (IMS).
- It contains parameters for identifying and authenticating the user to the IMS.
- The ISIM application can co-exist with SIM and USIM on the same UICC making it possible to use the same smartcard in both GSM networks and earlier releases of UMTS.
- It is specified in 3GPP TS 31.103 [3GPP2016] and described in e.g. [GSM2006].

## User Identifiers (“Identities”) and Secret

- The ISIM contains:
  - One “IM Private Identity”
  - One or more “IM Public Identities”
  - A long-term secret used to authenticate and calculate cipher keys
- The **IM Private Identity (IMPI)**
  - Unique global identifier per IMS subscriber: username@operator.com
  - Assigned by the home network operator
  - Used for e.g. registration, authorisation, administration, and billing
  - Not accessible to the user
  - Only visible to control nodes inside the IMS
  - One ISIM application includes only one IMPI - but an IMS user may have several UICC cards carrying an ISIM application or a UICC card with several different ISIM applications.
- **IM Public Identities (IMPUs)**
  - Every IMS subscriber has one or more IMPUs, e.g. user@operator.com, or tel:+1-212-555-12345.
  - Used for requesting communications to other users
  - Visible to the outside, e.g. to be shown on a business card

- **Service Profile**
  - identifies the services a user may currently use such as video telephony, VoIP, Presence
  - defined and maintained in the Home Subscriber Server (HSS) of the subscriber's home network
- **Home domain name**
  - The ISIM application stores the home domain name of the subscriber securely.
  - This can not be changed or modified.

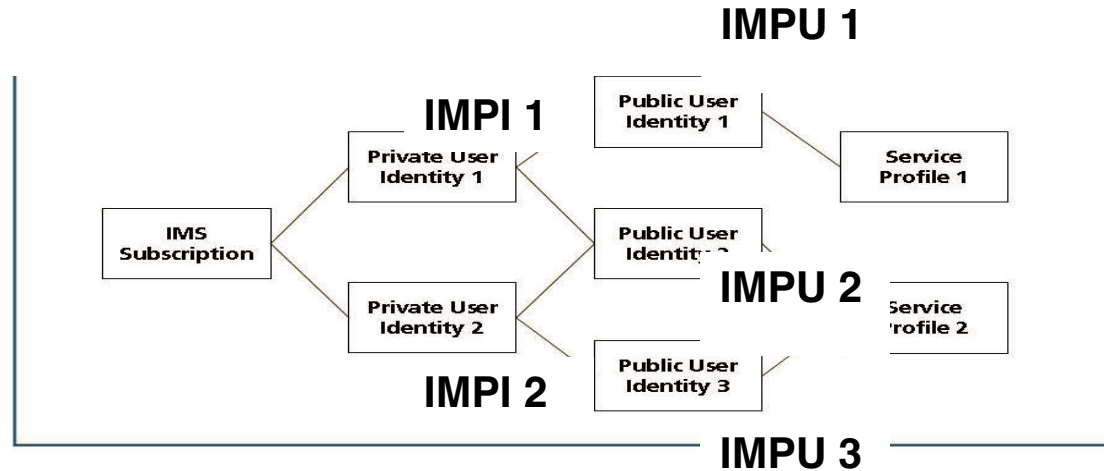

- In case of more than one IMS subscription, there may be a many-to-many mapping of IMPIs to IMPUs.
- Each IMPU is assigned exactly one Service Profile, but a Service Profile may be assigned to more than one IMPU.

- Smartcards – Introduction
- Subscriber Identity Module (SIM)
- WAP Identity Module (WIM)
- Universal SIM (USIM) and UICC
- IP Multimedia Services Identity Module (ISIM)
- Apple SIM
- Google Fi Project
- eSIM
- Applications – CamWebSIM



- Apple SIM is available for purchase in Australia, Canada, France, Germany, Italy, the Netherlands, Spain, Sweden, Switzerland, Turkey, the UK, and the US.
- SIM contains credentials for several networks.
- The customer must “activate” the desired network, which may dedicate the SIM to that network allowing no further change with that SIM.
- When travelling abroad, the customer can use the same SIM card for a chosen mobile data tariff from “selected” operators in +100 countries worldwide. [Wiki-AppleSIM]
- Available since October 2014.
- Costs in Germany:
  - SIM card for 5 EUR
  - 1 GB of data for a month for 50 EUR.
- In November 2016 supported by in cellular-enabled versions of its iPad Air 2, iPad mini 3, iPad mini 4, and iPad Pro tablets in Apple Retail Stores in Australia, Canada, France, Germany, Italy, Japan, the Netherlands, Spain, Sweden, Switzerland, Turkey, the United Kingdom, and the United States.

Source: <http://www.apple.com/ipad/LTE/>

- Smartcards – Introduction
- Subscriber Identity Module (SIM)
- WAP Identity Module (WIM)
- Universal SIM (USIM) and UICC
- IP Multimedia Services Identity Module (ISIM)
- Apple SIM
- Google Fi Project
- eSIM
- Applications – CamWebSIM





- Connectivity through different operators (since April 2015)
  - In cooperation with Sprint and T-Mobile, U.S. Cellular, and Three (joint SIM card)
  - Google is the contract partner to the subscriber.
  - Currently supported by:
    - LG G7 ThinQ, LG V35 ThinQ, LG V30, Moto X4, Moto G6, Moto G7, Nexus 6, Nexus 5X, Nexus 6P, Pixel and Pixel XL, Pixel 2 and Pixel 2 XL, Pixel 3 and Pixel 3 XL, Pixel 3a and Pixel 3a XL, iPhone 5S and later (beta)
  - Seamless switch between available Wi-Fi hotspots and the mobile network
- Simple price tariffs starting from \$20 per month (per person)
  - High-speed data coverage in 200+ countries and territories with the same conditions:
    - same rate pricing,
    - high speed data at \$10/GB,
    - unlimited domestic SMS and calls,
    - Unlimited “roaming” SMS and calls for 20¢ / minute,
    - Payable by credit or debit card.
  - Data tariff available in 200 destinations
  - Refund for the unused data each month
  - Group plans available, friends and family for additional \$15 per month each



Simply Unlimited	Unlimited Plus	Flexible
Our most affordable plan if you use lots of data, with 2-4 lines for the same price	Great for staying connected here and abroad, plus 1 year of YouTube Premium on us <sup>3</sup>	Our best plan if you want to only pay for the data you use
<p><b>\$80</b> for 2</p> <p>\$40 each</p> <p>+ taxes &amp; gov't fees</p>	<p><b>\$110</b> for 2</p> <p>\$55 each</p> <p>+ taxes &amp; gov't fees</p>	<p><b>\$35</b> for 2 + data</p> <p>\$18 each + \$10/GB</p> <p>+ taxes &amp; gov't fees</p>
<b>Data</b> ⓘ		
Data (in the US, Canada, & Mexico)		
 Unlimited	 Unlimited	 \$10/GB with Bill Protection
Data slower after		
35 GB	50 GB	15 GB



**What you always get**

-  Unlimited calls and texts
-  Full connectivity for select smartwatches
-  Spam call blocking and contact controls<sup>4,5</sup>
-  Family location sharing and content filters<sup>6,7</sup>
-  24/7 customer support

- Smartcards – Introduction
- Subscriber Identity Module (SIM)
- WAP Identity Module (WIM)
- Universal SIM (USIM) and UICC
- IP Multimedia Services Identity Module (ISIM)
- Apple SIM
- Google Fi Project
- eSIM
- Applications – CamWebSIM

- Characteristics of the embedded SIM (eSIM)
  - Embedded as a secure element in hardware (mobile devices, cars, household devices - to enable the deployment of IoT)
  - Likely implemented with a programmable ROM
  - Probably a “game changer”
    - Easy to switch providers/operators
    - Tariffs can be programmed/limited programmatically to devices, e.g. a 2-year contract can limit update to the card until the end of contract.
- Global standard being drafted by the GSMA, will require new terminal hardware

## The future is all about eSIM

Quick and easy registration and networking of Internet-enabled devices and cars

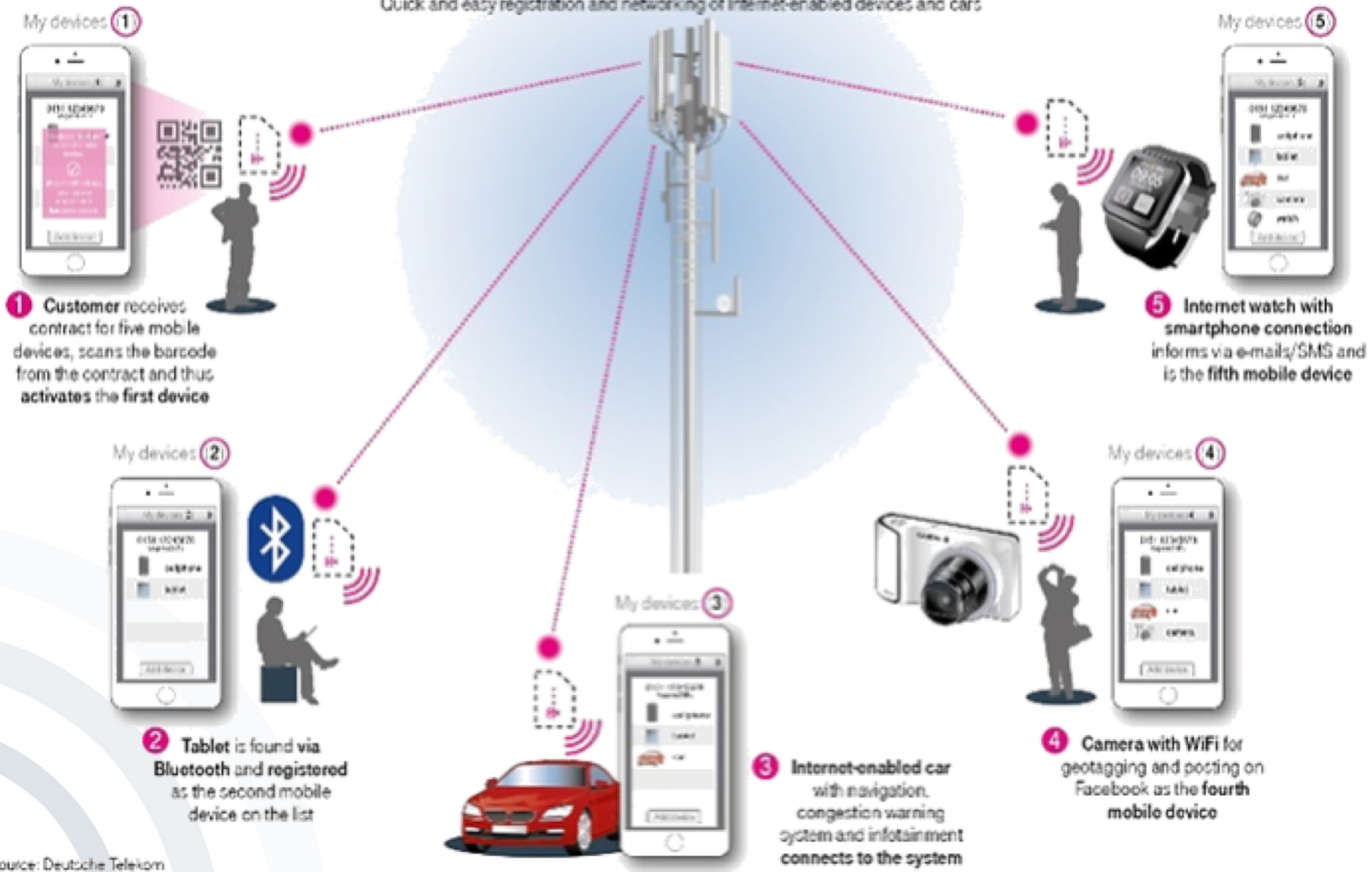

Source: Deutsche Telekom

## Die Zukunft spricht eSIM

Bequeme und schnelle Anmeldung und Vernetzung von internetfähigen Geräten und Autos

Meine Geräte (1)

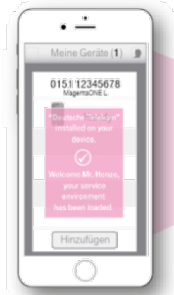

1 Kunde erhält Vertrag für fünf mobile Geräte, scannt Barcode vom Vertrag und aktiviert so erstes Gerät

Meine Geräte (5)



5 Internetuhr mit Smartphone-Anbindung informiert über E-Mails/SMS, ist fünftes mobiles Gerät

Meine Geräte (2)



2 Tablet wird über Bluetooth gefunden und als zweites mobiles Gerät auf der Liste angemeldet

Meine Geräte (3)



3 internetfähiges Auto mit Navigation, Stauwarner und Infotainment verbindet sich mit System

Meine Geräte (4)



4 Kamera mit WLAN für Geotagging und posten in Facebook ist viertes mobiles Gerät

Quelle: Deutsche Telekom

- German market situation
  - Vodafone and O2 provided the first product/tariff with eSIM [Telefonica2016, Vodafone2016].
  - Cubic Telecom eSIM available in Audi vehicles with Audi Connect since 2016 [Audi2016], and in Volkswagen vehicles with We Connect since 2018 [Volkswagen2018].
  - Telekom eSIM available in BMW vehicles with BMW ConnectedDrive available since 2016 [Telekom2016].
  - Cubic Telecom, an Irish telecommunications company, is a producer of worldwide connectivity solutions, and provider of the eSIM in-car connectivity and network data packages. Cubic's global connected software solutions power more than 8 million vehicles across 100 countries for leading automotive brands, including Volkswagen Group, CNH Industrial, Arrival and e.GO Mobile, as well key technology players such as Microsoft and Kymeta. [Cubic2023]
- Uncertainties
  - Fears of limited customer choice of operator/tariff (preselected list of operators)
  - Business models (shifting the power from the network operators to device vendors)



- Smartcards – Introduction
- Subscriber Identity Module (SIM)
- WAP Identity Module (WIM)
- Universal SIM (USIM) and UICC
- IP Multimedia Services Identity Module (ISIM)
- Apple SIM
- Google Fi Project
- eSIM
- Applications – CamWebSIM



## ▪ A smaller personal security device

HTTP server (!) in the GSM SIM card

- A SIM based on the MS Smart Card can be programmed



Connection between GSM and Internet

- HTTP Requests via HTTP/SMS Gateway to mobile phone

More than a cool demo ...

- Explore the relation between PDAs and Smart Cards
  - What can really be done on the Smart Card?
  - Can Smart Card encrypt info to be stored in the PDA?
- Explore the possibilities of extra interaction channels
  - SMS in parallel to Internet
- Research Authorisation vs. Authentication vs. Identification

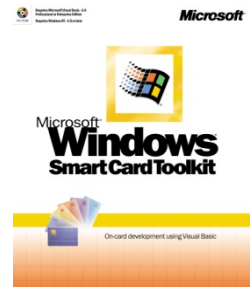



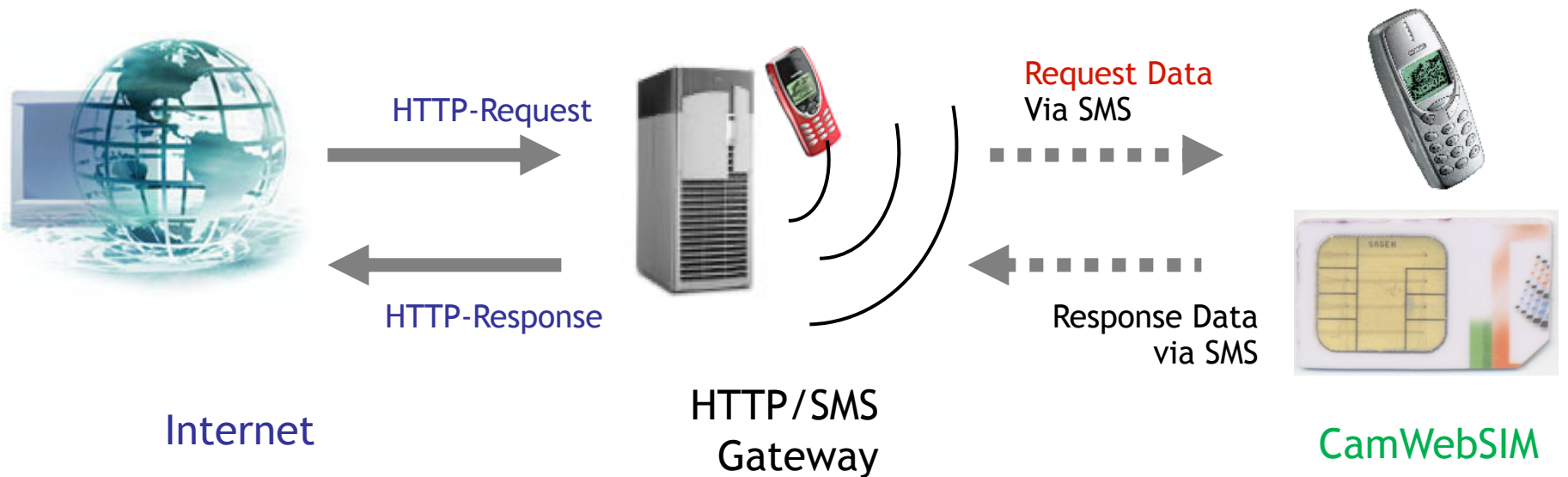

[`http://www.camwebsim.telco.com/+14253334711/dt=\(Hello World\)`](http://www.camwebsim.telco.com/+14253334711/dt=(Hello World))

- Website
  - <http://www.camwebsim.telco.com/>
- Tel-No.
  - +14253334711/
- Command (SIM AT V 2.0 ++)
  - dt=(Hello World!)
  - LOCATION INFO info
  - SELECT ITEM si=(title,item1,item2,...)
  - DISPLAY TEXT dt=(text)
  - GET INPUT gi=(text)
  - MAIL NOTIFICATION mail=(who,subj,phone)
  - SIGN CHEQUE cq=(who,amount)

Website

Tel.-No.

Command



## ■ More Payment Channels

- Telephone Bill
- ...

Toys.com  
3 Gimmicks  
▶ Pay \$ 27.80  
Cancel  
Help



si=(Toys.com 3 Gimmicks, Pay \$ 27.80, Cancel, Help)

# Payment Authorisation live

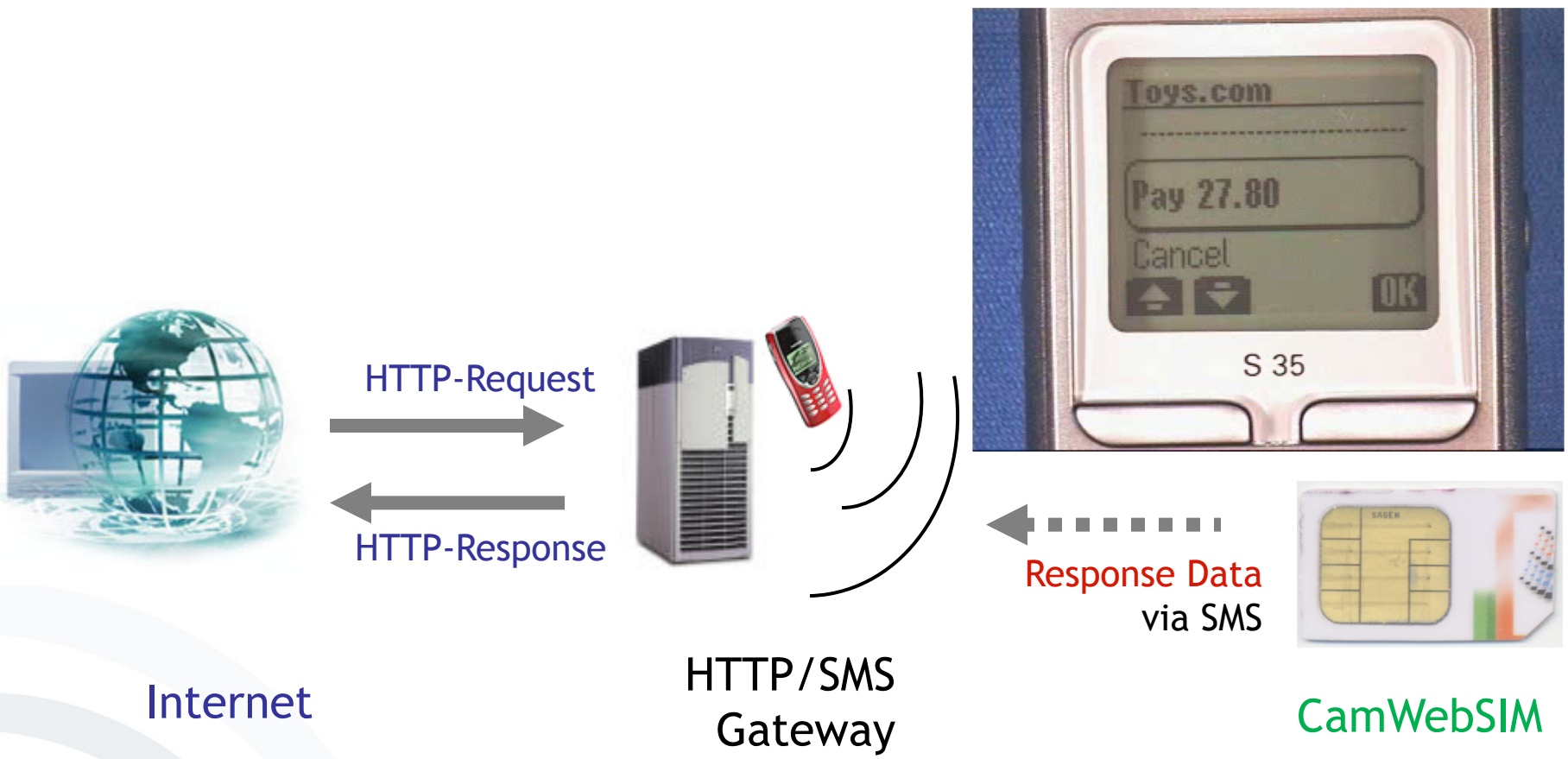

[www.camwebsim.telco.com/+14253334711/](http://www.camwebsim.telco.com/+14253334711/)  
 si=(Toys.com 3 Gimmicks, Pay 27.80, Cancel, Help)

## ■ Technologywise

- Connected a smart card to the Internet

*Goal: transparent, uniform access to smart card services*

- Used the mobile phone as a trusted device

*Assumed a secure path between SIM and display/keyboard*

*! This might be (more) dangerous with more complex phones*

- Used the existing GSM infrastructure and security model for payment authorisation

*User authentication key is stored in the SIM*

- ...

- Applicationwise

- ...

- Used the existing GSM infrastructure and security model for payment authorisation

- User authentication key is stored in the SIM*

- *Provided a telecom with a new revenue channel based on an existing process*

- Telecoms as payment servers (the Teletext model)*

- *Enabled cash-like payment for Internet services*

- In countries where one does not need to register a name with a prepaid GSM account*



ATMEL 3232/ ... 8 bit CPU  
5 MHz, 32K Flash, 32K EEPROM,  
1K RAM  
9600 Bit/s serial I/O

Sagem Smart Card

## SMS limits

- No guaranteed delivery times
- 140 “real” Bytes just cover a 128 Bytes signed message ...
- ... and sometimes not even that
- We look forward to GPRS.

## Space limits

- More than 32K in the chip would be helpful.

## Phone capability limits

- SIM Application Toolkit Support is being interpreted widely ...

- Website
  - <http://www.camwebsim.telco.com/>
- Tel-No.
  - +14253334711/
- Command (SIM AT V 2.0 ++)
  - dt=(Hello World!)
  - LOCATION INFO info
  - SELECT ITEM si=(title,item1,item2,...)
  - DISPLAY TEXT dt=(text)
  - GET INPUT gi=(text)
  - MAIL NOTIFICATION mail=(who,subj,phone)
  - SIGN CHEQUE cq=(who,amount)

Website

Tel.-No.

Command



- [3GPP2016] 3GPP (2013), <https://portal.3gpp.org/desktopmodules/Specifications/SpecificationDetails.aspx?specificationId=1804>, accessed 2016-11-17
- [Audi2016], What is the Audi connect e-SIM and the advantages for drivers, accessed 2019-09-16,
- [Wahtphone2021] <https://whatphone.com.au/guide/what-is-the-audi-connect-e-sim-and-the-advantages-for-drivers/>
- [Cubic2023] <https://www.cubictelcom.com/media/press/cubic-telecom-and-qualcomm-join-efforts-to-deliver-innovative-connectivity-solutions-for-enhanced-services-and-infotainment-systems/>, accessed 2023-11-21
- [DTAG2014] Deutsche Telekom: SIM-Kartenformate, [www.t-mobile.de/sim-kartenformate/0,27115,28905-,00.html](http://www.t-mobile.de/sim-kartenformate/0,27115,28905-,00.html), accessed 2014-11-05.
- [EffingRankl2008] Effing, Wolfgang and Rankl, Wolfgang (2008) Handbuch der Chipkarten: Aufbau - Funktionsweise - Einsatz von Smart cards, Hanser-Verlag
- [GSM2006] GSM Specification, [www.3gpp.org/ftp/Specs/archive](http://www.3gpp.org/ftp/Specs/archive), accessed 2013-10-03
- [GSM2013] GSM Association (2013), GSM Technology, [www.gsma.com/aboutus/gsm-technology/gsm](http://www.gsma.com/aboutus/gsm-technology/gsm), accessed 2014-09-03
- [GSM2015] GSM Association (2015), GSM Technology, [www.gsma.com/aboutus/gsm-technology/gsm](http://www.gsma.com/aboutus/gsm-technology/gsm), accessed 2015-11-02
- [GSMA2019] Definitive data and analysis for the mobile industry, <http://gsmaintelligence.com> (accessed 2019-08-12)
- [GSMA2021] The Mobile Economy 2021, [https://www.gsma.com/mobileeconomy/wp-content/uploads/2021/07/GSMA-MobileEconomy2021\\_3.pdf](https://www.gsma.com/mobileeconomy/wp-content/uploads/2021/07/GSMA-MobileEconomy2021_3.pdf) (accessed 2022-11-17)
- [GSMA2022] The Mobile Economy 2022, <https://www.gsma.com/mobileeconomy/wp-content/uploads/2022/02/280222-The-Mobile-Economy-2022.pdf> (accessed 2022-11-17)
- [Heise2015] Heise.de (2015), “Deutsche Telekom: eSIM soll 2016 kommen”, <http://www.heise.de/newsticker/meldung/Deutsche-Telekom-eSIM-soll-2016-kommen-2921732.html>, accessed 2016-11-28

- [Investopedia2016] 10 Countries With the Most McDonald's Locations (MCD), <http://www.investopedia.com/articles/markets-economy/091716/10-countries-most-mcdonalds-locations-mcd.asp> (accessed on 2016-11-30)
- [ITU2016] International Telecommunication Union, ICT Facts and Figures 2016, <http://www.itu.int/en/ITU-D/Statistics/Documents/facts/ICTFactsFigures2016.pdf>, accessed 2014-09-03
- [McDonalds2016] McDonald's Corporation (2016), [http://www.aboutmcdonalds.com/mcd/our\\_company.html](http://www.aboutmcdonalds.com/mcd/our_company.html), accessed 2016-11-30
- [McDonalds2022] <https://corporate.mcdonalds.com/corpmcd/franchising-overview.html#:~:text=McDonald's%20is%20the%20world's%20leading,by%20independent%20local%20business%20owners>. (accessed 2022-11-17)
- [SecCommerce2013] SecCommerce (2013), Überblick über Smartcards, [www.seccommerce.de/de/component/content/article/39-root-de/knowledge/technology/122-smartcard-architecture.html](http://www.seccommerce.de/de/component/content/article/39-root-de/knowledge/technology/122-smartcard-architecture.html), accessed 2013-10-10
- [T3n2015] T3n.de (2015), “Warum die eSim von Apple und Samsung eine Katastrophe für Nutzer und Netzbetreiber ist [Kommentar]”, <http://t3n.de/news/esim-apple-samsung-katastrophe-624523/>, accessed 2015-11-18
- [Telefonica2016] Erste Smartwatch mit eSIM bei O2, 2016-02-18, <https://blog.telefonica.de/2016/02/mobile-world-congress-2016-erste-smartwatch-mit-esim-bei-o2/>, accessed 2016-11-28
- [Telekom2015] The future speaks eSIM, 2015-11-19, <https://www.telekom.com/en/blog/group/article/the-future-speaks-esim-62202>, accessed 2016-11-28
- [Telekom2016] Deutsche Telekom moves the motor car onto the data highway, 2016-7-22, <https://www.telekom.com/en/media/media-information/archive/deutsche-telekom-moves-the-motor-car-onto-the-data-highway-436076>, accessed 2017-08-16
- [UN2019] Growth in United Nations membership, 1945-present. <http://www.un.org/en/sections/member-states/growth-united-nations-membership-1945-present/index.html>, accessed 2019-08-12
- [UN2022] <https://www.un.org/en/about-us> (accessed 2022-11-17)

- [Vodafone2016] eSIM technology will extend the mobile ecosystem, accessed 2016-02-19, <http://www.vodafone.com/content/index/what/technology-blog/esim-technology.html>, accessed 2016-11-28
- [Volkswagen2018] Always on - In the digital fast lane with the eSIM, accessed 2019-09-16, <https://www.volkswagen-newsroom.com/en/press-releases/technology-in-the-new-touareg-part-6-always-on-in-the-digital-fast-lane-with-the-esim-3930>
- [Wiki2014] Subscriber identity module, [en.wikipedia.org/wiki/Subscriber\\_identity\\_module#Formats](https://en.wikipedia.org/wiki/Subscriber_identity_module#Formats), accessed 2014-11-06
- [Wiki2019] Wikipedia, List of countries with McDonald's restaurants, [https://en.wikipedia.org/wiki/List\\_of\\_countries\\_with\\_McDonald's\\_restaurants](https://en.wikipedia.org/wiki/List_of_countries_with_McDonald's_restaurants) accessed 2019-08-12
- [Wiki2022] Wikipedia, List of countries with McDonald's restaurants, [https://en.wikipedia.org/wiki/List\\_of\\_countries\\_with\\_McDonald%27s\\_restaurants](https://en.wikipedia.org/wiki/List_of_countries_with_McDonald%27s_restaurants) accessed 2022-11-17
- [Wiki-AppleSIM] Apple SIM, [https://en.wikipedia.org/wiki/Apple\\_SIM](https://en.wikipedia.org/wiki/Apple_SIM), accessed 2019-08-12