

Lecture 11

Market Overview of Mobile Operating Systems and Security Aspects

Mobile Business I (WS 2023/24)

Prof. Dr. Kai Rannenber

Chair of Mobile Business & Multilateral Security
Goethe University Frankfurt a. M.



- The market for mobile devices and mobile OS
- Mobile OS unavailable to other device manufacturers
 - Overview
 - Palm OS
 - Apple iOS (Unix-based)
- Manufacturer-independent mobile OS
 - Overview
 - Symbian platform (by Symbian Foundation)
 - Embedded Linux
 - Android (by Open Handset Alliance)
 - Microsoft Windows CE, Pocket PC, Pocket PC Phone Edition, Mobile
 - Microsoft Windows Phone / 10 Mobile
 - Firefox OS
 - KaiOS
 - HarmonyOS
- Threats, attacks and countermeasures
 - Threats and attacks
 - Countermeasures

Worldwide smartphone sales to end users by operating system (2009 - 04/2023)

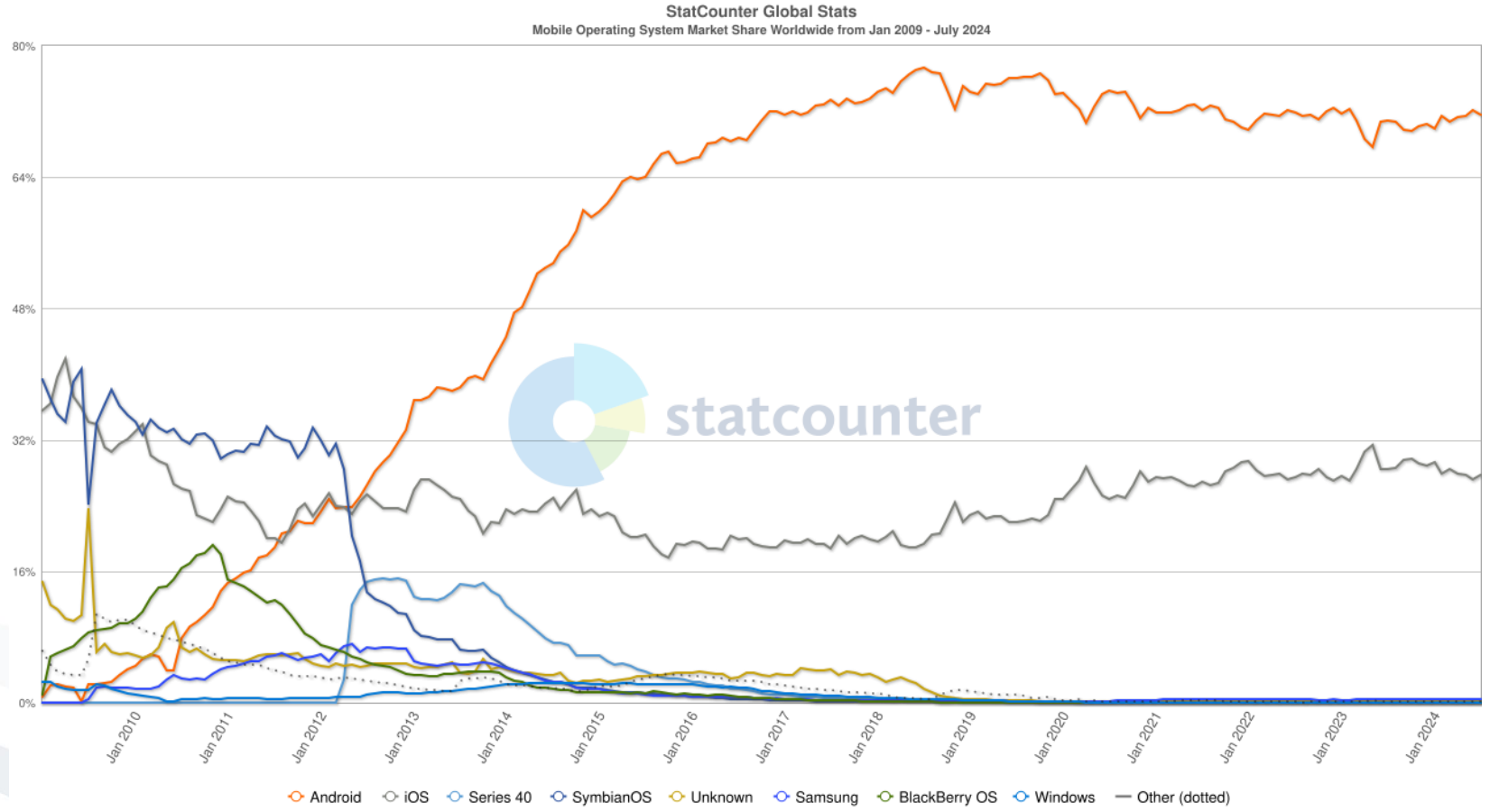

OS

Worldwide smartphone sales to end users by operating system (2017/18)

Operating System	1Q18 Units	1Q18 Market Share (%)	1Q17 Units	1Q17 Market Share (%)
Android	329,313.9	85.9	325,900.9	86.1
iOS	54,058.9	14.1	51,992.5	13.7
Other OS	131.1	0.0	607.3	0.2
Total	383,503.9	100.0	378,500.6	100.0

Operating System	2Q18 Units	2Q18 Market Share (%)	2Q17 Units	2Q17 Market Share (%)
Android	329,503.4	88.0	321,848.2	87.8
iOS	44,715.1	11.9	44,314.8	12.1
Other OS	112.1	0.0	433.1	0.1
Total	374,330.6	100.0	366,596.1	100.0

Worldwide smartphone sales to end users by operating system (Q2 2013)

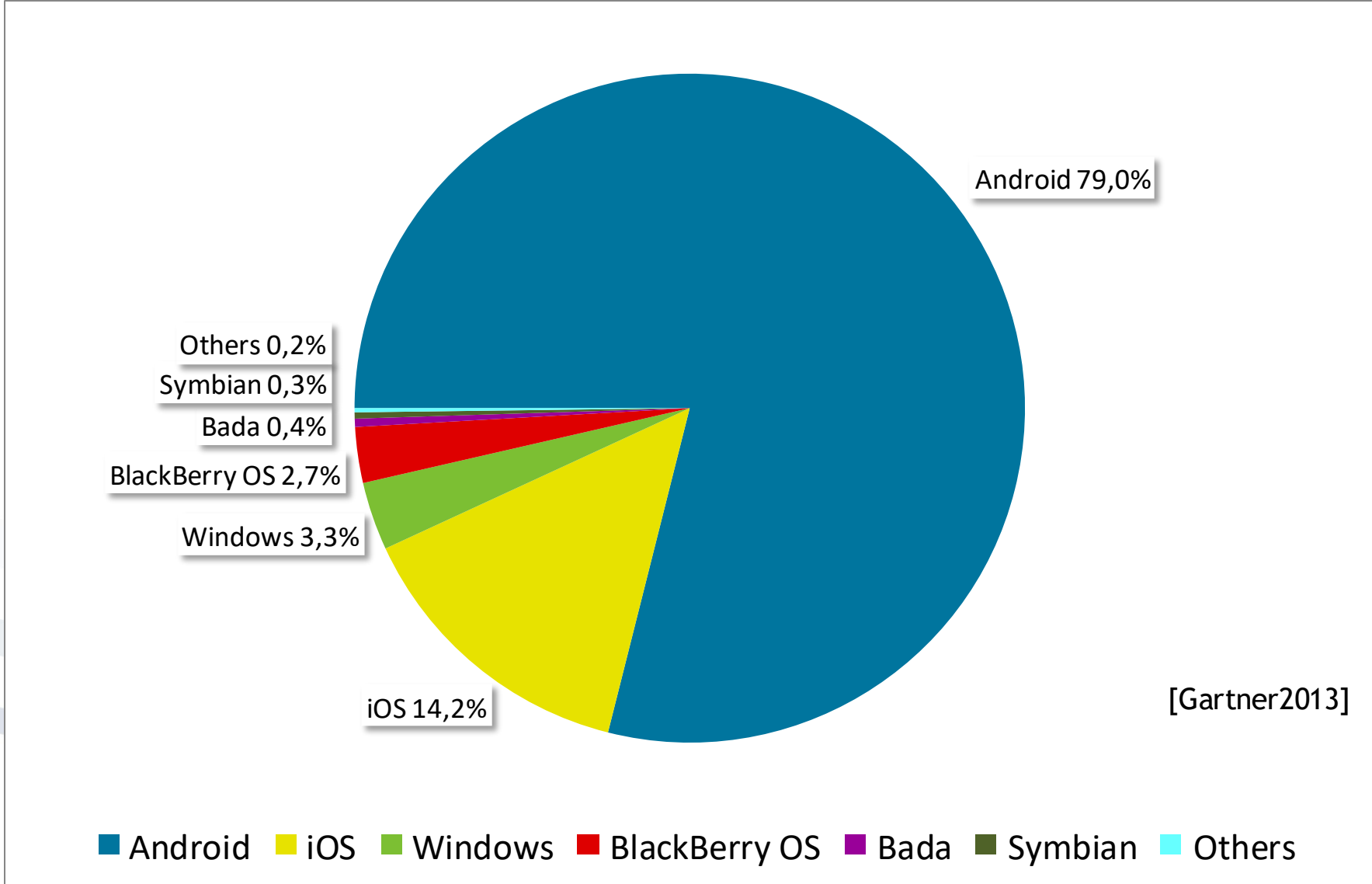

Worldwide smartphone sales to end users by operating system (Q2 2014)

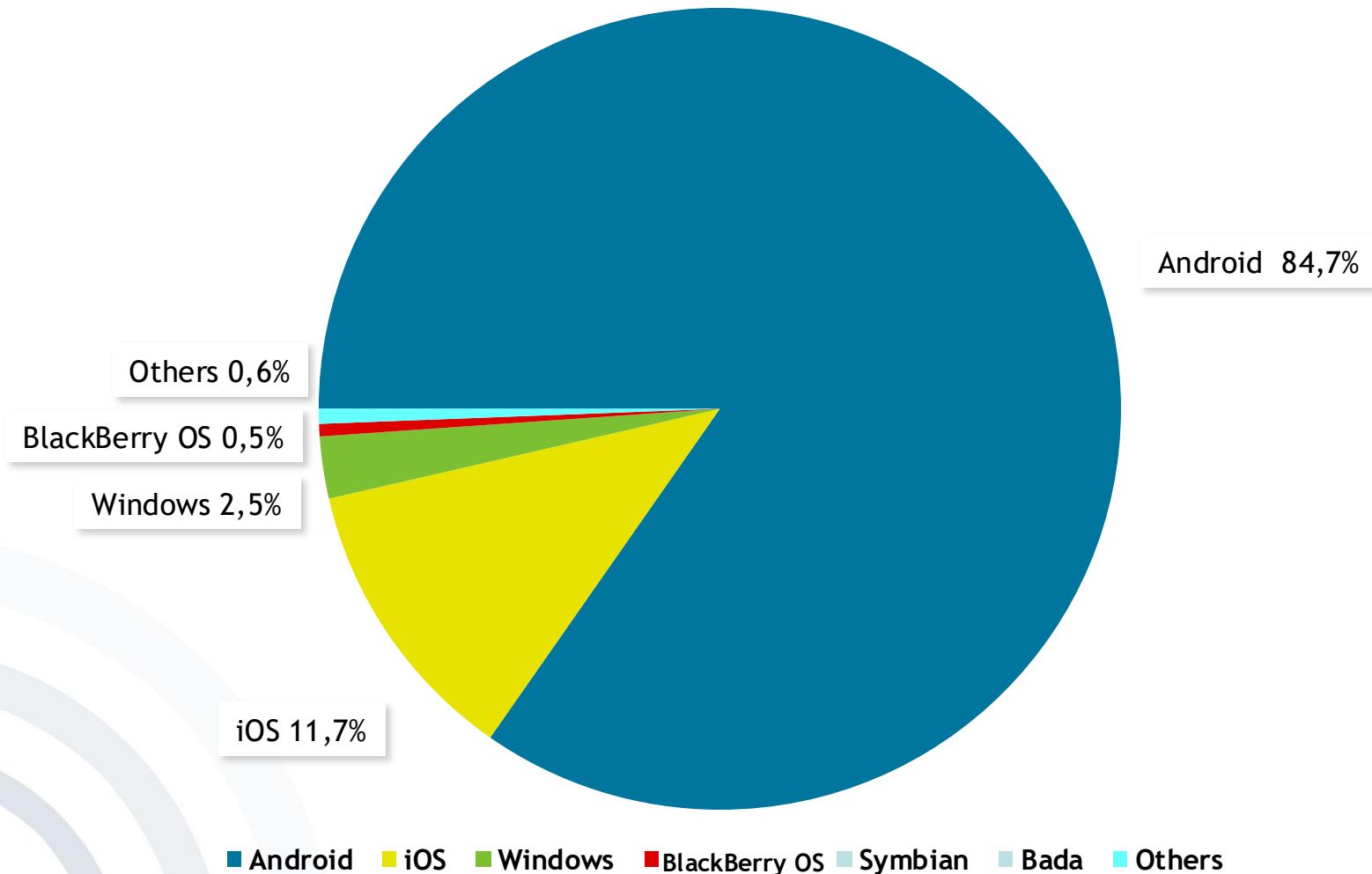

Worldwide smartphone sales to end users by operating system (Q2 2015)

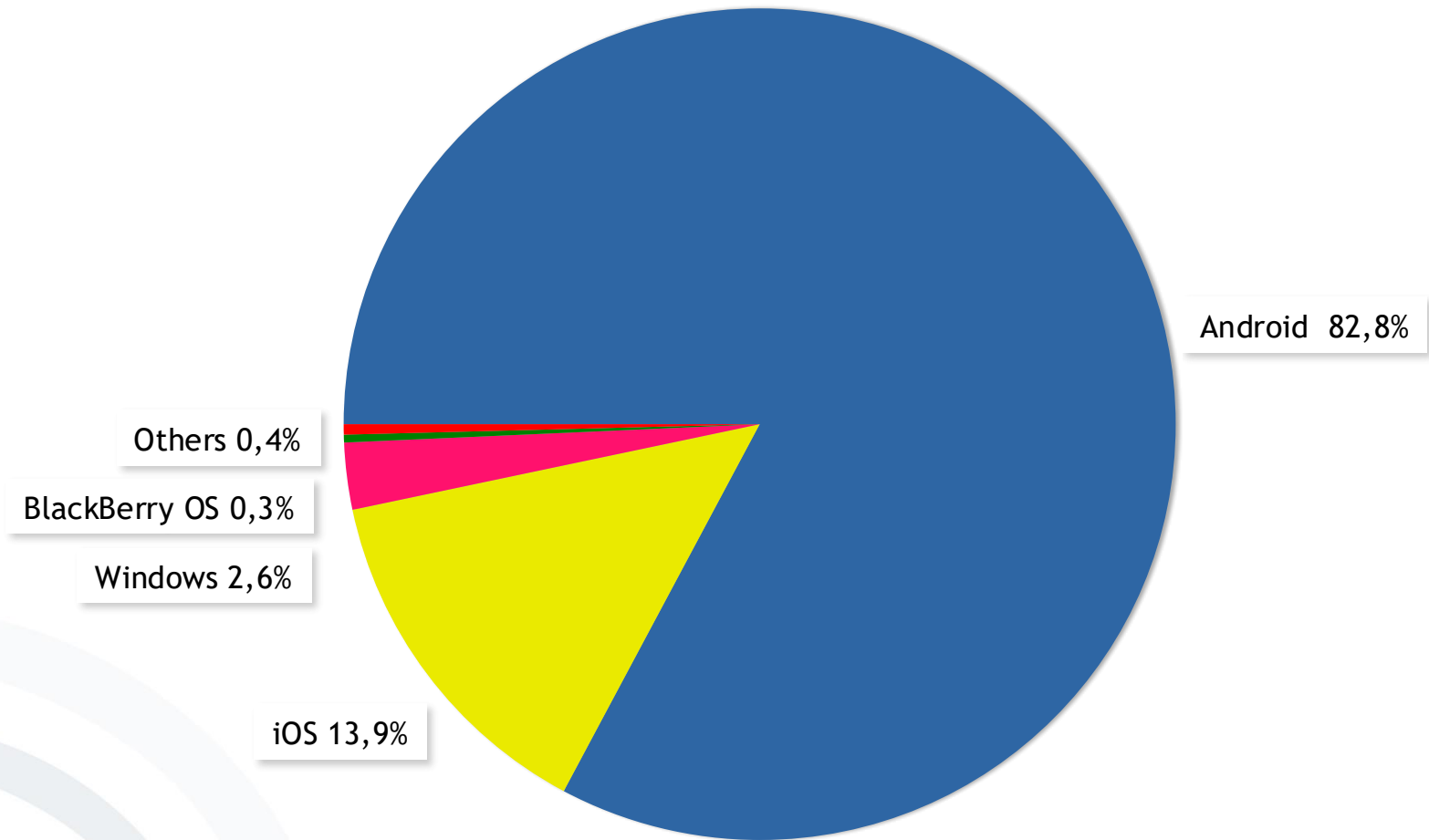

Worldwide smartphone sales to end users by operating system (Q2 2016)

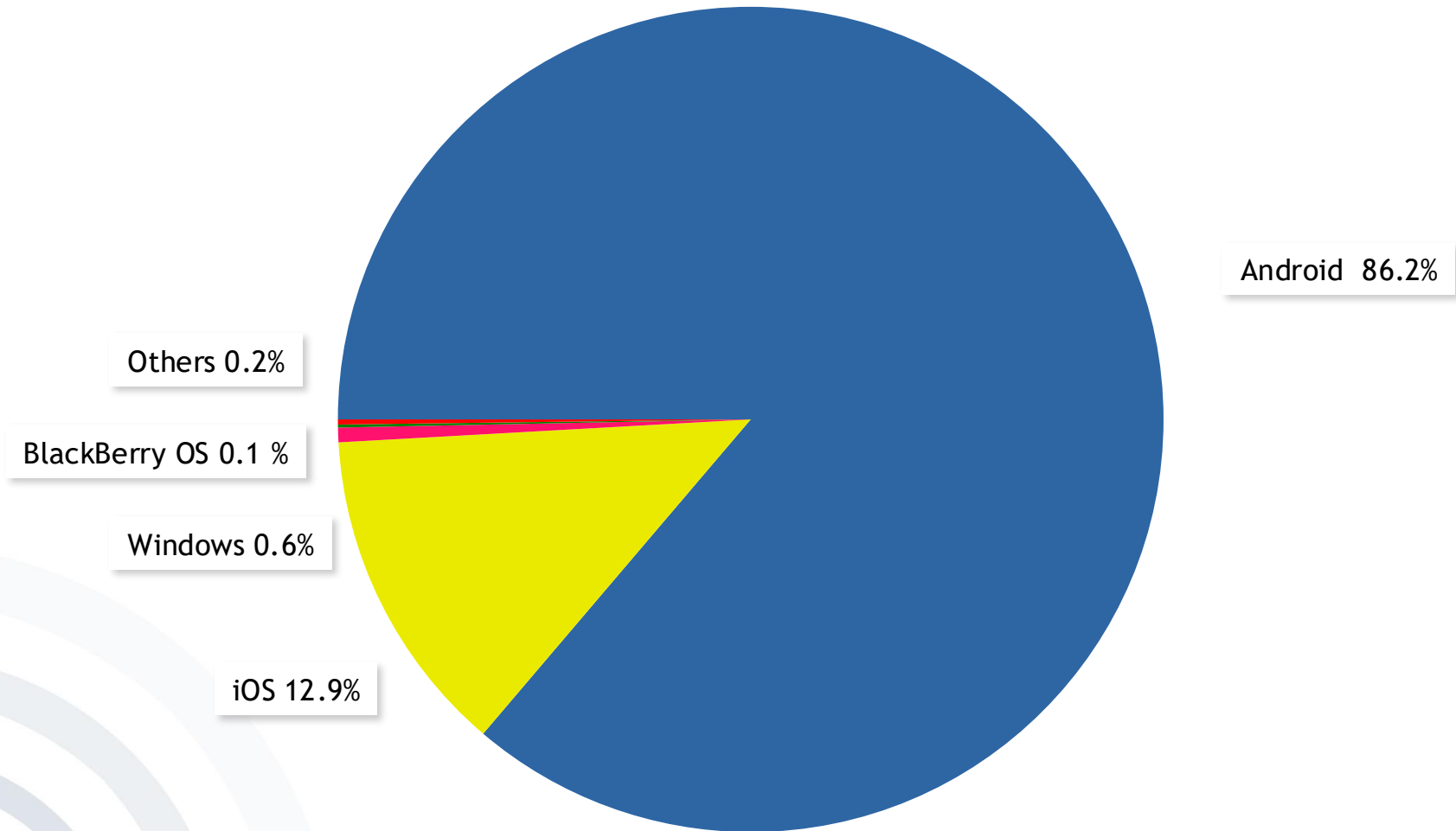

Worldwide smartphone sales to end users by operating system (Q2 2017)

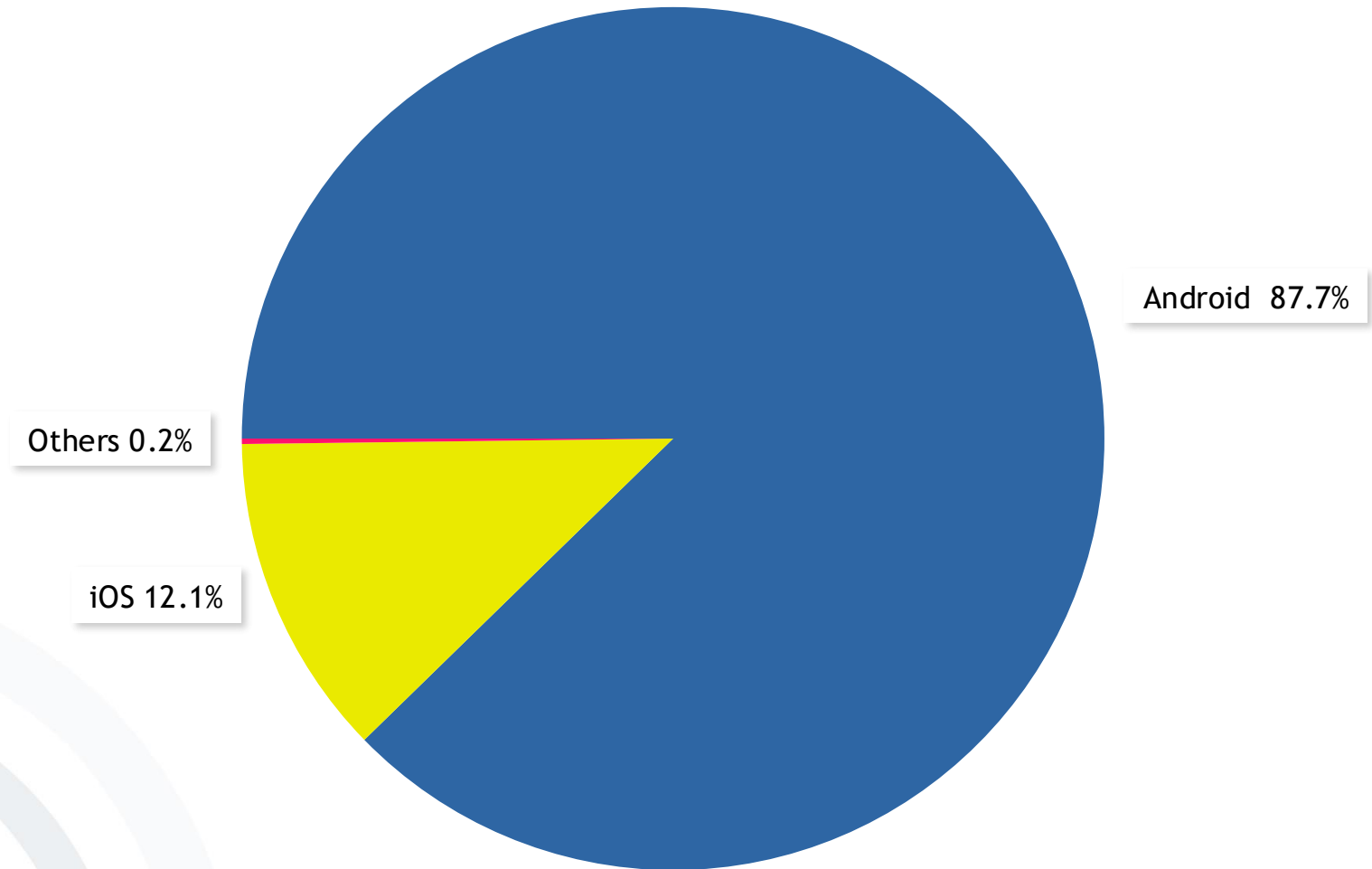

US installed smart phone base by operating system (Q2 2013)

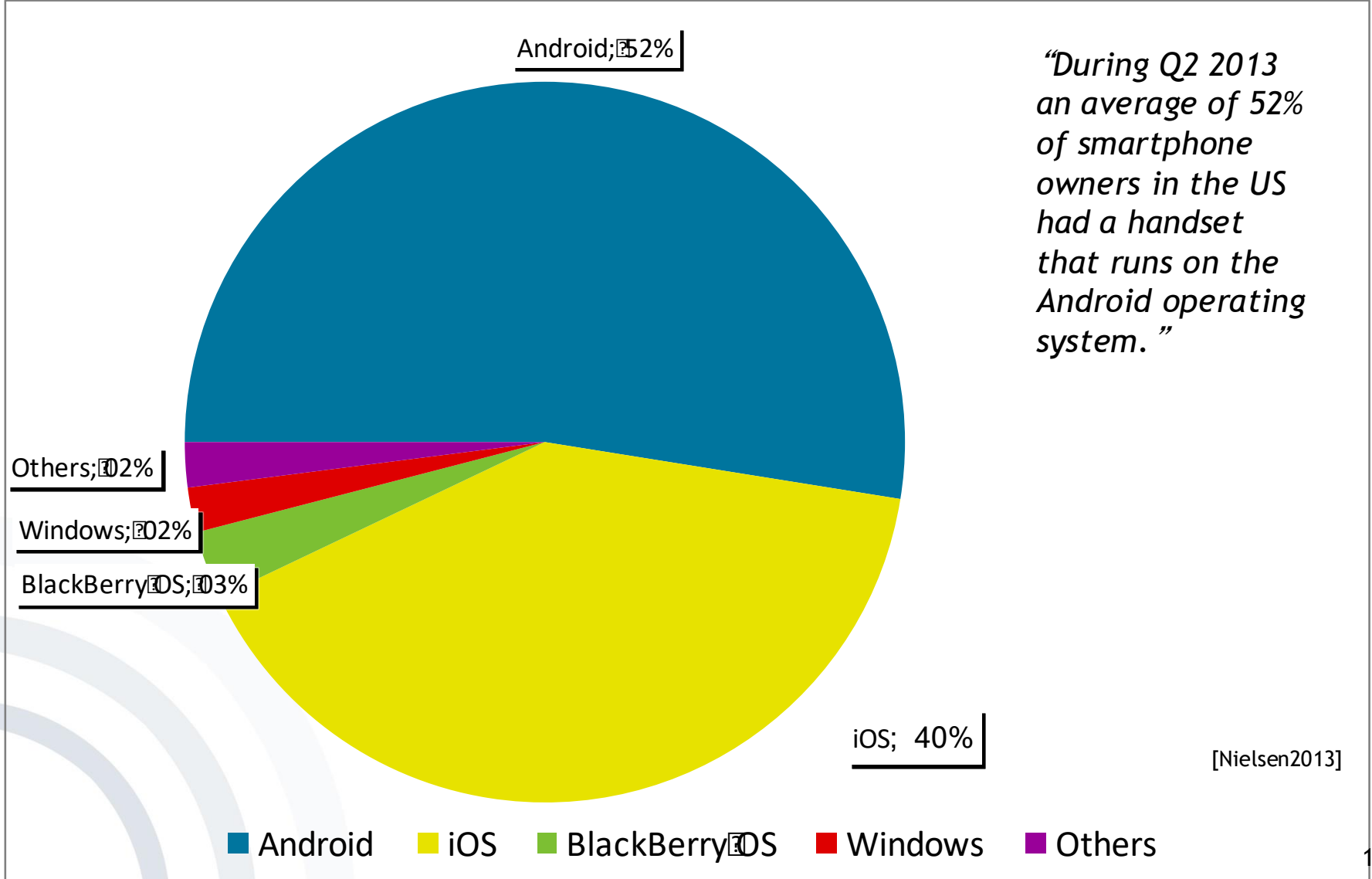

US installed smart phone base by operating system (July 2014)

*“During July 2014
an average of
51,5% of
smartphone
owners in the US
had a handset
that runs on the
Android operating
system.”*

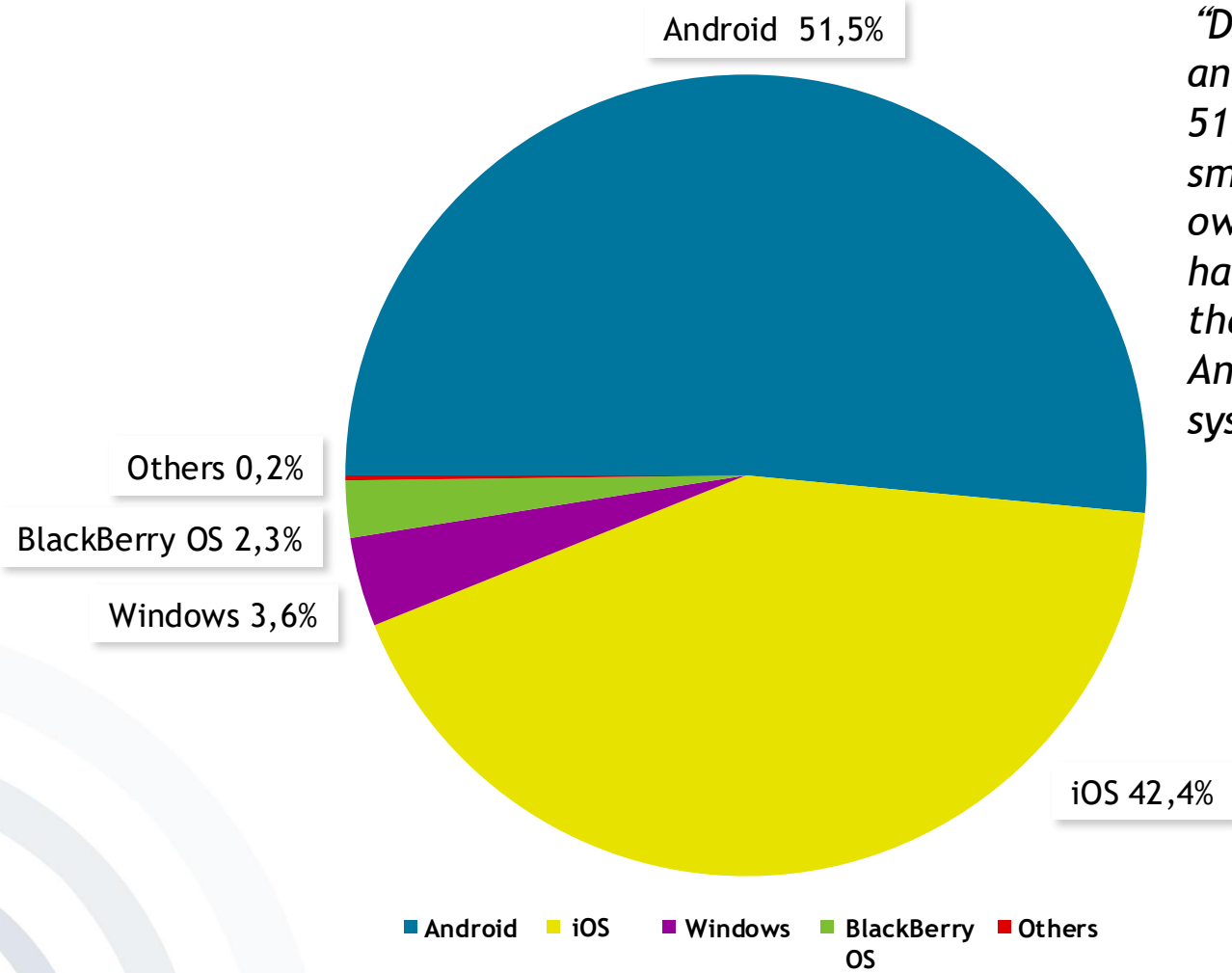

US installed smart phone base by operating system (July 2015)

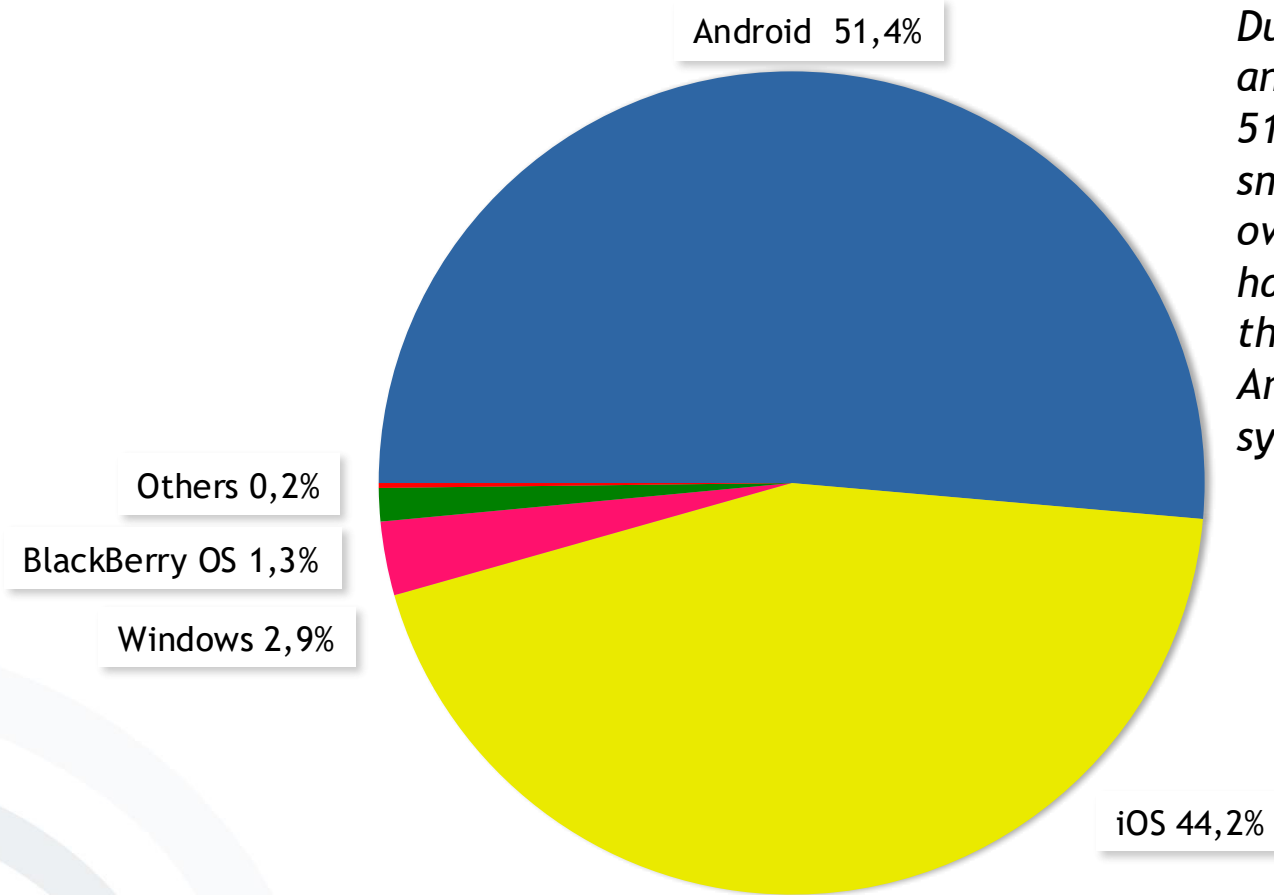

*During July 2015
an average of
51,4% of
smartphone
owners in the US
had a handset
that runs on the
Android operating
system.*

US installed smart phone base by operating system (July 2016)

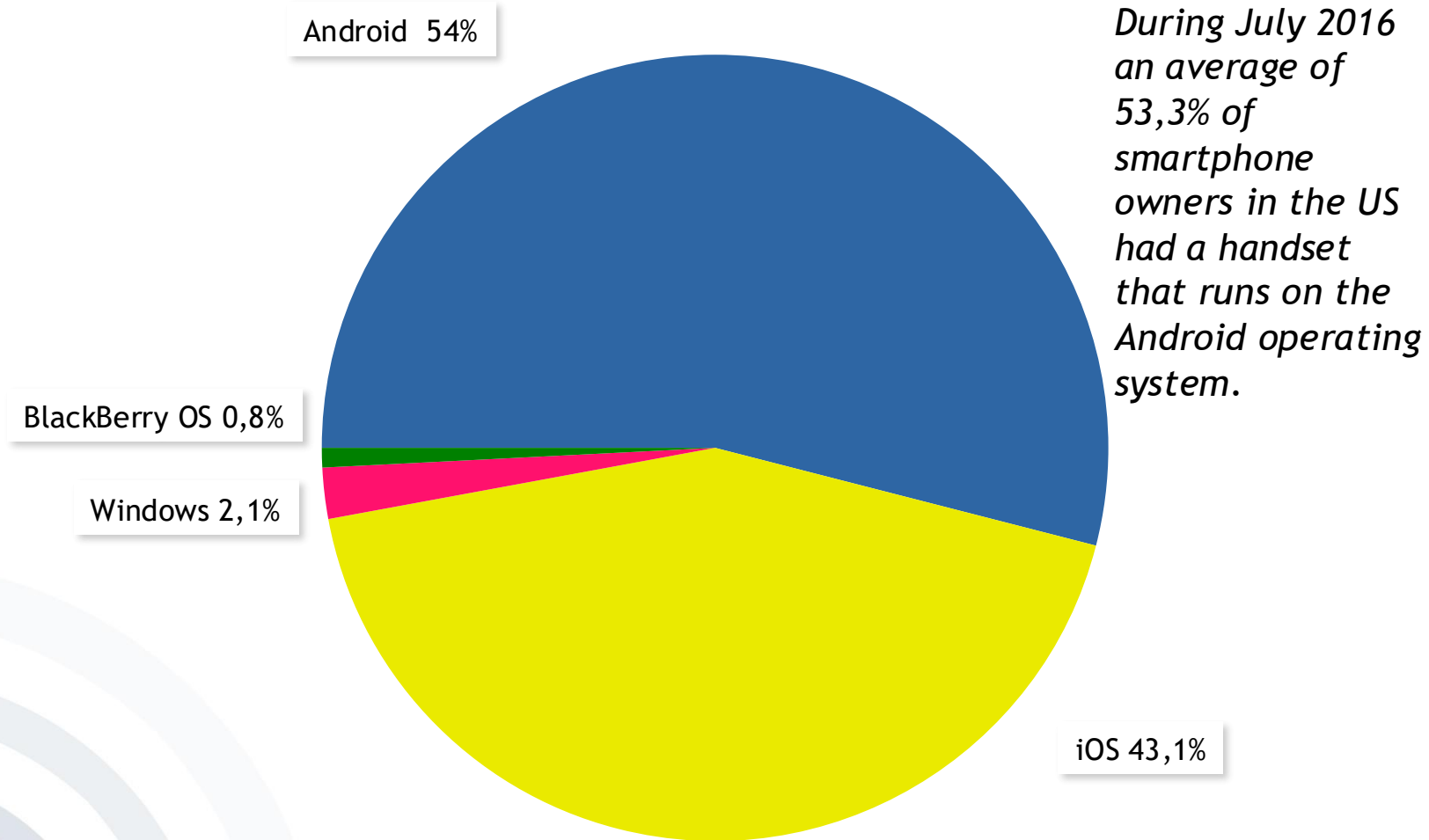

US installed smart phone base by operating system (June 2017)

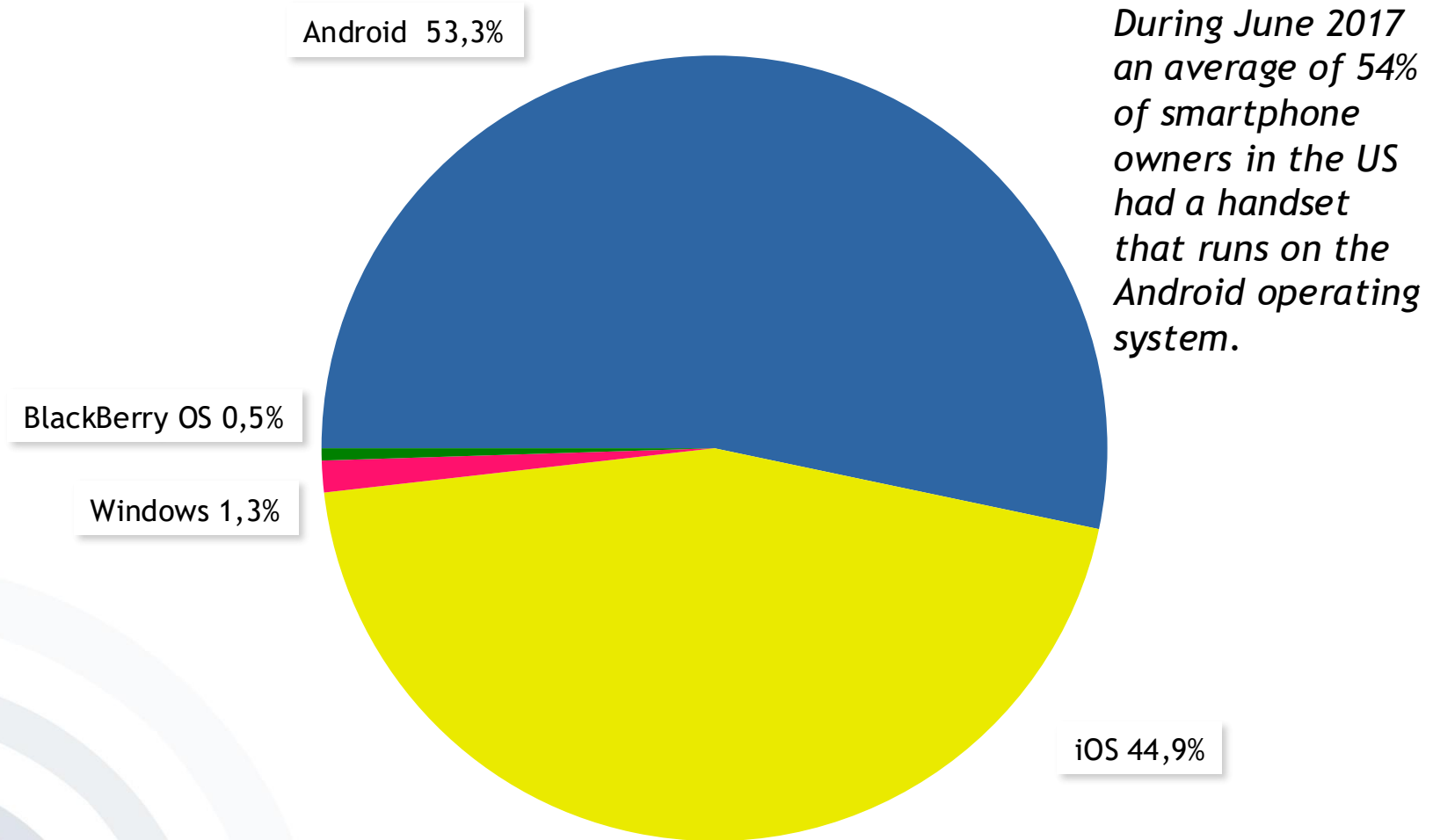

Worldwide smartphone sales to end users
by operating system
Q2-2016 vs. Q2-2015 vs. Q2-2014

In 1.000 Units

Operating System	2Q16 Units	2Q16 Market Share (%)	2Q15 Units	2Q15 Market Share (%)	2Q14 Units	2Q14 Market Share (%)
Android	296,912.8	86.2	271,010	82.2	243,484	83.8
iOS	44,395.0	12.9	48,086	14.6	35,345	12.2
Windows	1,971.0	0.6	8,198	2.5	8,095	2.8
BlackBerry OS	400.4	0.1	1,153	0.3	2,044	0.7
Others	680.6	0.2	1,229.0	0.4	1,416.8	0.5
TOTAL	344,359.7	100.0	329,676.4	100.0	290,384.4	100.0

Worldwide smartphone sales to end users
by vendor
Q2-2017 vs. Q2-2016 vs. Q2-2015

In 1.000 Units

Company	2Q17 Units	2Q17 Market Share (%)	2Q16 Units	2Q16 Market Share (%)	2Q15 Units	2Q15 Market Share (%)
Samsung	82,535.1	22.5	76,743.5	22.3	72,072.5	21.9
Apple	44,314.8	12.1	44,395.0	12.9	48,085.5	14.6
Huawei	35,964.3	9.8	30,670.7	8.9	25,825.8	7.8
Lenovo*	Others		Others		16,405.9	5.0
OPPO	26,092.5	7.1	18,489.6	5.4	Others	
Others	177,327.7	48.4	174,061.0	50.5	167,286.6	50.8
TOTAL	366,234.4	100.0	344,359.7	100.0	329,676.4	100.0

[Gartner2015,Gartner2016]

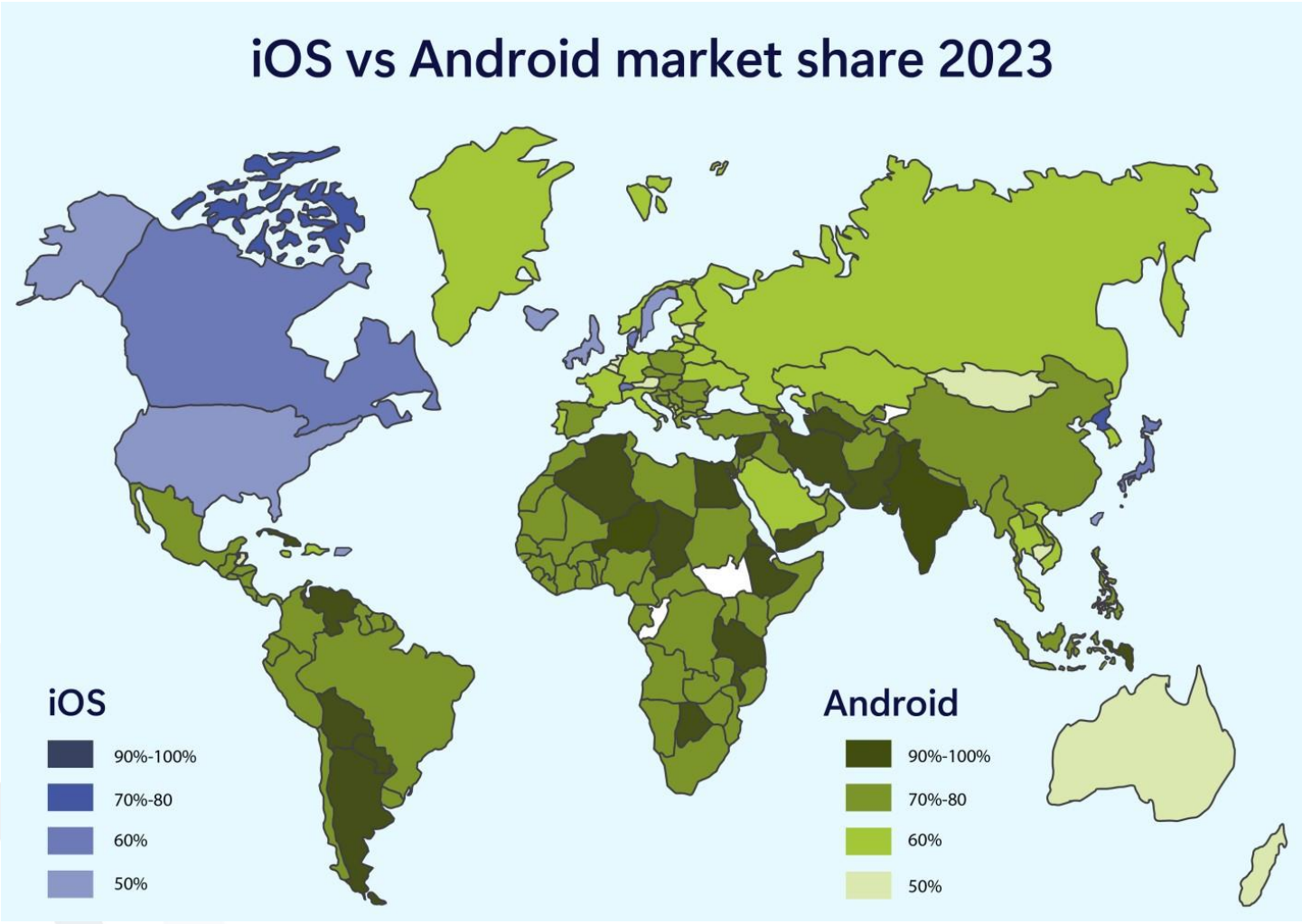

[Zamaqo, 2024]

Long term trends (maybe?)

- Big players (originally from neighbouring fields) often have some (sometimes relatively modest) market share due to high investment:
 - Microsoft: Architectures, operating systems
 - Nokia: Feature phones
- Killer Application Champions are very successful for some time until their killer application is also available from the big players:
 - Palm: 1st small and affordable PDA with address book, calendar, and PC connectivity
 - RIM Blackberry: 1st PDA phone with push email

- Due to the limitations of the mobile devices, mobile operating systems also have to cope with the following challenges:
 - Limited device capabilities and resources (storage, memory, processing time, etc.)
 - Usability issues
 - Security and system integrity issues

- The market for mobile devices and mobile OS
- Mobile OS unavailable to other device manufacturers
 - Overview
 - Palm OS
 - Apple iOS (Unix-based)
- Manufacturer-independent mobile OS
 - Overview
 - Symbian platform (by Symbian Foundation)
 - Embedded Linux
 - Android (by Open Handset Alliance)
 - Microsoft Windows CE, Pocket PC, Pocket PC Phone Edition, Mobile
 - Microsoft Windows Phone / 10 Mobile
 - Firefox OS
 - KaiOS
 - HarmonyOS
- Threats, attacks and countermeasures
 - Threats and attacks
 - Countermeasures

- Originally, most mobile phone manufacturers used their own “closed” operating systems for their mobile devices.



- *Palm OS (Garnet OS)*
 - Latest release: Palm OS Cobalt 6.1 in February 2004



- *Apple iOS (Unix-based)*
 - Latest release: iOS 17.6.1. (August 7. 2024)



- *BlackBerry OS*
 - Latest release: BlackBerry OS 10.3.3 (June 2018)
 - Newer Blackberry models (*PRIV, DTEK60, and DTEK50*) run on Android



- *LuneOS (formerly WebOS, initially developed by Palm, later HP)*
 - Latest release: LuneOS Egnog Latte (Oct 2019)
 - Not to be confused with Palm OS (now: Garnet OS) that was also initially developed by Palm



- *Samsung bada*
 - Latest release: v2.0, e.g. on Samsung Wave 3 S8600 (discontinued 2013)

- **Advantage:** Tend to be not as much affected by malware compared to operating systems available to many external manufacturers
- **Disadvantage:** Less flexible, as 3rd-party software cannot be easily installed and executed
- Later, more and more platforms switched to more open and interoperable operating systems (e.g. Windows CE, Symbian OS, Android).

- The market for mobile devices and mobile OS
- Mobile OS unavailable to other device manufacturers
 - Overview
 - Palm OS
 - Apple iOS (Unix-based)
- Manufacturer-independent mobile OS
 - Overview
 - Symbian platform (by Symbian Foundation)
 - Embedded Linux
 - Android (by Open Handset Alliance)
 - Microsoft Windows CE, Pocket PC, Pocket PC Phone Edition, Mobile
 - Microsoft Windows Phone / 10 Mobile
 - Firefox OS
 - KaiOS
 - HarmonyOS
- Threats, attacks and countermeasures
 - Threats and attacks
 - Countermeasures

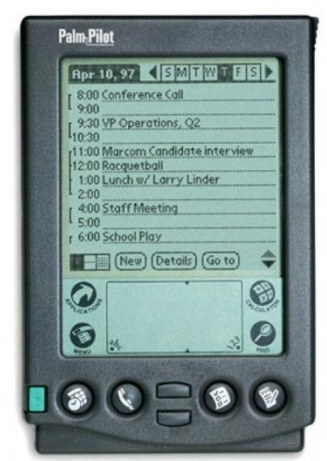

All screens are simulated.

- The operating system is made by *palmsource*
- Several device manufacturers:
 - Palm (e.g. Treo series)
 - Handspring
 - Garmin (navigation devices)
 - Fossil
 - Samsung
 - Sony
 - ...
- Last version 6.1 (Cobalt) - 2004
 - There are no devices using version 6.1 on the market. Most of the devices are equipped with Palm OS 5.4 (Garnet), such as the Tungsten series.



- Communication:
 - IrDA
 - Bluetooth
 - WiFi (IEEE 802.11)
 - GSM/GPRS
 - CDMA
- Support of the TCP/IP network protocol
- Integrated personal information management (PIM)
- Support for several encryption and security algorithms (e.g. RSA, SHA1, RC4)
- Large choice of 3rd party software available
- Long battery life



- 1996: Palm Pilot 1000, first device using Palm OS
- 1998: Palm III using Palm OS v3
- 2000: Palm IIIc, first device using Palm OS and a colour display
- 2003: Palm OS 5
- 2004: Palm OS 6.1 (Cobalt) and Palm OS 5.4 (Garnet)
- 2006: Palm's "*Treo Smartphones*" with Windows Mobile
- Name change to Garnet OS - future versions to be based on the Access Linux platform
- 2010: Hewlett-Packard acquired Palm for \$1,2 billion, name change to HPwebOS
- 2011: HP announced to stop the production of all HPwebOS devices, including smart phones and tablets

- The market for mobile devices and mobile OS
- Mobile OS unavailable to other device manufacturers
 - Overview
 - Palm OS
 - Apple iOS (Unix-based)
- Manufacturer-independent mobile OS
 - Overview
 - Symbian platform (by Symbian Foundation)
 - Embedded Linux
 - Android (by Open Handset Alliance)
 - Microsoft Windows CE, Pocket PC, Pocket PC Phone Edition, Mobile
 - Microsoft Windows Phone / 10 Mobile
 - Firefox OS
 - KaiOS
 - HarmonyOS
- Threats, attacks and countermeasures
 - Threats and attacks
 - Countermeasures

Apple iOS

- Developed by Apple for iPhone, iPod Touch, iPad, Apple Watch (watchOS) and Apple TV (tvOS)
- Latest release: iOS 17.6.1
- iOS derived from Mac OS X, a Unix-based operating system
- Apple does not permit the OS to run on third-party hardware.



- The market for mobile devices and mobile OS
- Mobile OS unavailable to other device manufacturers
 - Overview
 - Palm OS
 - Apple iOS (Unix-based)
- **Manufacturer-independent mobile OS**
 - Overview
 - Symbian platform (by Symbian Foundation)
 - Embedded Linux
 - Android (by Open Handset Alliance)
 - Microsoft Windows CE, Pocket PC, Pocket PC Phone Edition, Mobile
 - Microsoft Windows Phone / 10 Mobile
 - Firefox OS
 - KaiOS
 - HarmonyOS
- Threats, attacks and countermeasures
 - Threats and attacks
 - Countermeasures



- Linux: LiMo (Linux Mobile), Openmoko Linux, Qt Extended (Qttopia)



- Symbian platform

- Latest release: "Nokia Belle Feature Pack 2" for Symbian^3 devices (Oct. 2012)



- Android (by Open Handset Alliance)



- Latest release: 14.0.0_r61 (August. 2024)



- Windows Mobile

- Latest release: Windows 10 Mobile 1703 (10.0.15254.603) (Jan. 2020)



- Windows Phone

- Latest release: Windows Phone 8.1



- Maemo (by Nokia) → MeeGo (by Nokia, Intel) → Sailfish OS (by Jolla)

- Latest release: Sailfish OS 4.6.0.11 (Sauna) (May 20 2024)



- Tizen (by Samsung, Intel, Linux Foundation)



- Latest release: 8.0 M2 (Oct. 2023)



- Firefox OS (by non-profit organisation Mozilla)



- Latest release: 2.2.0 (April 2015) - Discontinued in September 2016



- KaiOS (by Boot to Gecko)



- Latest release: 3.1 (March 2022)



= Linux-based



- HarmonyOS (by Huawei)

- Launched in August 2019 - Latest version 4.2 (April 11 2024)

- The market for mobile devices and mobile OS
- Mobile OS unavailable to other device manufacturers
 - Overview
 - Palm OS
 - Apple iOS (Unix-based)
- Manufacturer-independent mobile OS
 - Overview
 - Symbian platform (by Symbian Foundation)
 - Embedded Linux
 - Android (by Open Handset Alliance)
 - Microsoft Windows CE, Pocket PC, Pocket PC Phone Edition, Mobile
 - Microsoft Windows Phone / 10 Mobile
 - Firefox OS
 - KaiOS
 - HarmonyOS
- Threats, attacks and countermeasures
 - Threats and attacks
 - Countermeasures



symbian

Symbian OS - the mobile operating system

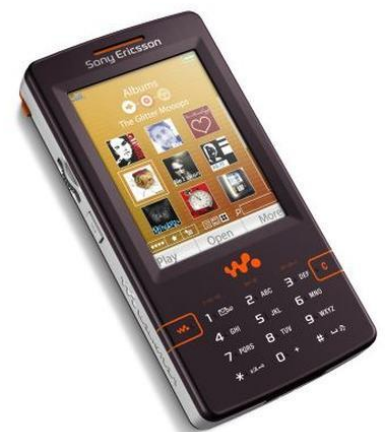

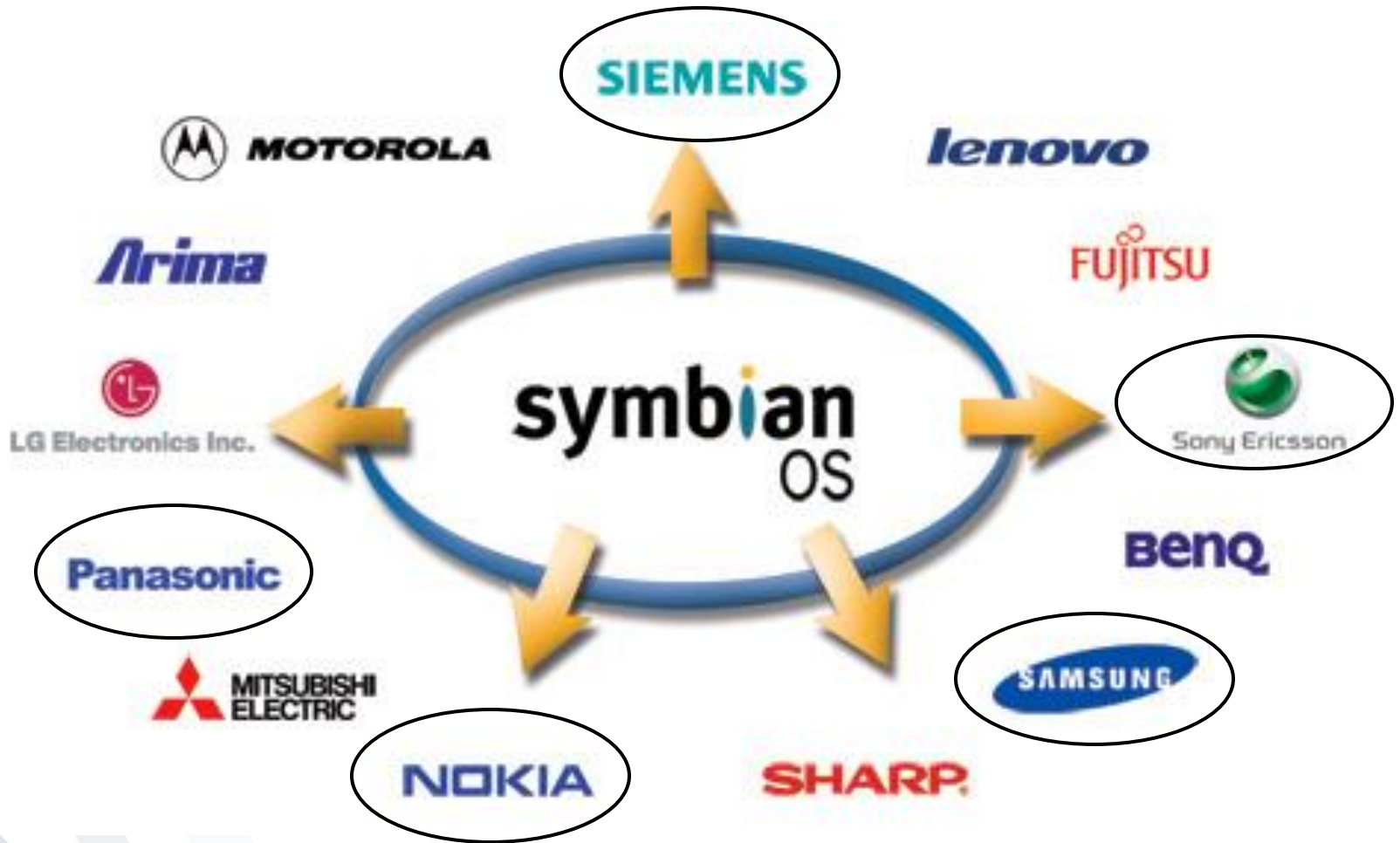

In 2006, Symbian was owned by 

- Symbian was founded as a privately owned company in June 1998.
- Owner: Ericsson, Nokia, Panasonic, Psion, Samsung Electronics, Siemens and Sony Ericsson
- „Open“ Symbian OS telephones were available since 2001
 - „Open“: It is possible to install 3rd-party applications.
 - Beginning of 2001: Nokia 9210 Communicator
- 2004: Symbian OS 8.0
- 2005: Symbian OS 9.1 (S60 3rd edition)
- 2006: Symbian OS 9.3 released, extending the OS with WiFi and HSDPA
- 2007: Symbian OS 9.4 (S60 5th edition) = Symbian^1 („Symbian One“)
- 2008 June: **Symbian Foundation** announced
- 2008 December: **Nokia** buys Symbian Ltd. and becomes the **major contributor** to code of Symbian platform



- 2009: Symbian Foundation founded
Symbian platform successor to Symbian OS and Nokia Series 60.
- 2010: Symbian OS 9.5 (Symbian^3). Nokia N8 first smartphone to run Symbian^3.
- 2010 November: Due to a lack of support from funding members, **Symbian Foundation transition into a licensing-only organisation**. Nokia takes over governance of the Symbian platform.
- 2011: Symbian Anna and Symbian Belle as an update to Symbian^3
- 2011 February: Nokia collaborates with Microsoft and adopts Windows Phone 7 for their smartphones. **Relevance of Symbian platform, especially in the mobile app market, drops significantly**. Market share in sharp decline, notably in the high priced smartphone segment
- 2011 September: Nokia **outsources** Symbian software development and 2,300 employees to Accenture
- 2012: Symbian Belle renamed to Nokia Belle
- 2013: Nokia Belle Feature Pack 2 (latest version)
- 2014 January: No new applications can be published in the Nokia Store (store.ovi.com) [Nokia2013]
- 2015 January: Nokia Store discontinued and partially transferred to Opera Mobile Store.



- The market for mobile devices and mobile OS
- Mobile OS unavailable to other device manufacturers
 - Overview
 - Palm OS
 - Apple iOS (Unix-based)
- Manufacturer-independent mobile OS
 - Overview
 - Symbian platform (by Symbian Foundation)
 - Embedded Linux
 - Android (by Open Handset Alliance)
 - Microsoft Windows CE, Pocket PC, Pocket PC Phone Edition, Mobile
 - Microsoft Windows Phone / 10 Mobile
 - Firefox OS
 - KaiOS
 - HarmonyOS
- Threats, attacks and countermeasures
 - Threats and attacks
 - Countermeasures



- Linux is an „*Open Source*“ operating system.
- Only a limited amount of device manufacturers were offering devices with a pre-installed Linux solution (e.g. Motorola, NEC, Panasonic).
- However, there are several Linux distributions, such as μ CLinux, that can be installed on existing devices (e.g. iPAQ).
- Motorola, as one of the major mobile phone manufacturers, was using Linux as (one) of their OS platforms.

- The market for mobile devices and mobile OS
- Mobile OS unavailable to other device manufacturers
 - Overview
 - Palm OS
 - Apple iOS (Unix-based)
- Manufacturer-independent mobile OS
 - Overview
 - Symbian platform (by Symbian Foundation)
 - Embedded Linux
 - Android (by Open Handset Alliance)
 - Microsoft Windows CE, Pocket PC, Pocket PC Phone Edition, Mobile
 - Microsoft Windows Phone / 10 Mobile
 - Firefox OS
 - KaiOS
 - HarmonyOS
- Threats, attacks and countermeasures
 - Threats and attacks
 - Countermeasures

- Open Handset Alliance (OHA) established in 2007
- Google and other members of the OHA collaborated to develop and release Android.
- Android based on modified version of Linux kernel
- October 2008: First commercially available phone running Android: T-Mobile G1
- October 2023: Version 14

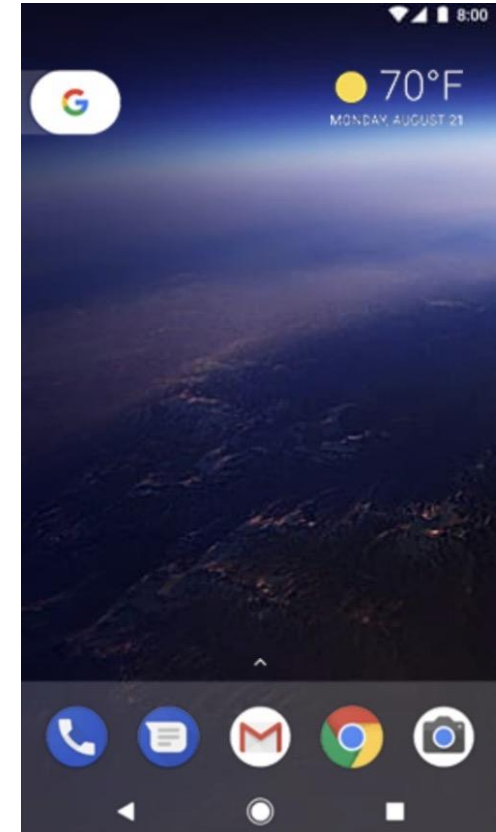

- The market for mobile devices and mobile OS
- Mobile OS unavailable to other device manufacturers
 - Overview
 - Palm OS
 - Apple iOS (Unix-based)
- Manufacturer-independent mobile OS
 - Overview
 - Symbian platform (by Symbian Foundation)
 - Embedded Linux
 - Android (by Open Handset Alliance)
 - Microsoft Windows CE, Pocket PC, Pocket PC Phone Edition, Mobile
 - Microsoft Windows Phone / 10 Mobile
 - Firefox OS
 - KaiOS
 - HarmonyOS
- Threats, attacks and countermeasures
 - Threats and attacks
 - Countermeasures

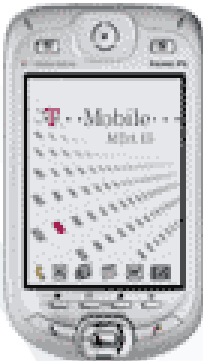

All screens are simulated.



Windows CE Timeline

Source: "A Brief History of Windows CE" (<http://www.hpcfator.com/support/windowsce/>), HPC:Factor, retrieved May 21, 2007

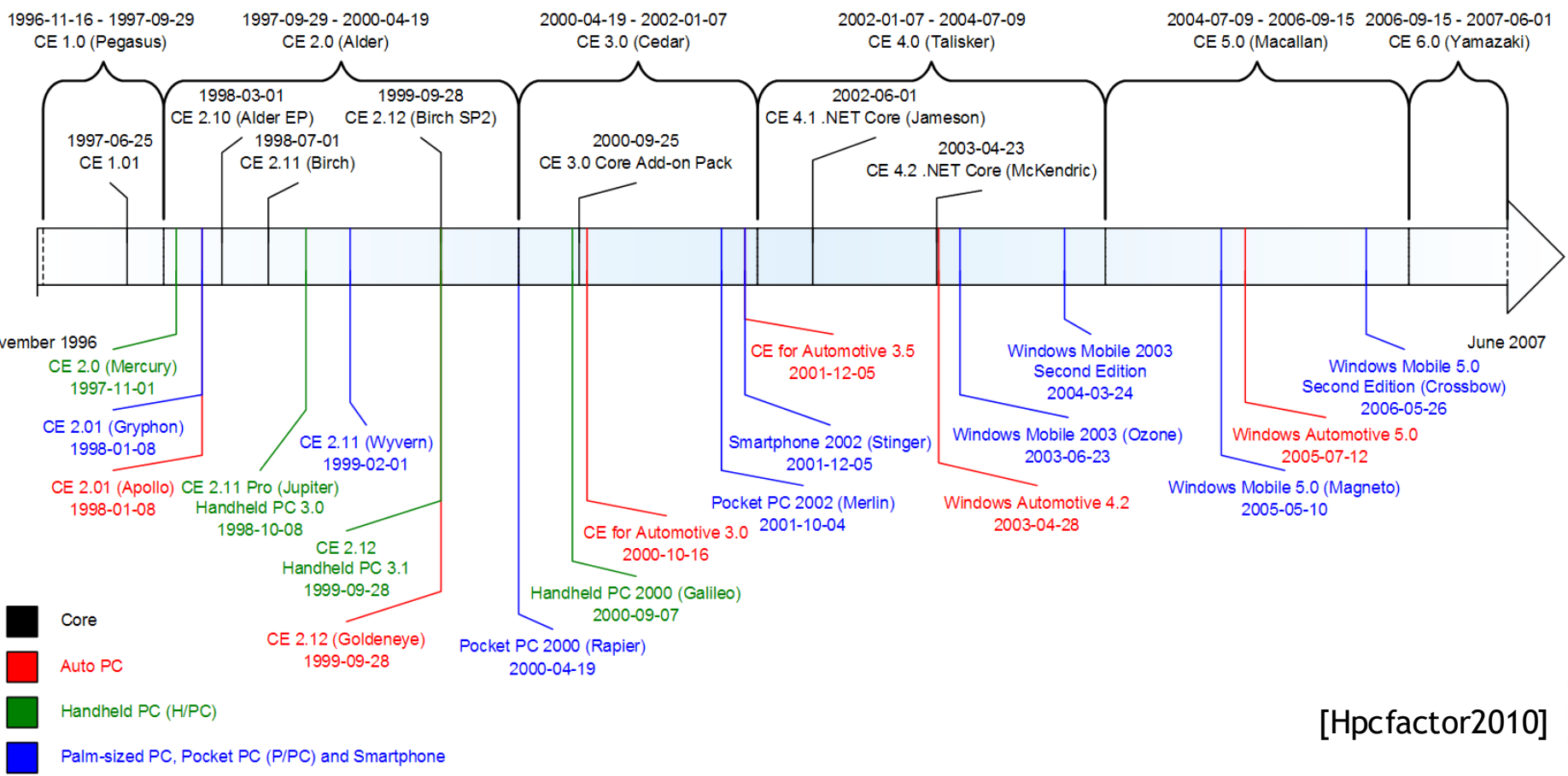

[Hpcfator2010]

- The market for mobile devices and mobile OS
- Mobile OS unavailable to other device manufacturers
 - Overview
 - Palm OS
 - Apple iOS (Unix-based)
- Manufacturer-independent mobile OS
 - Overview
 - Symbian platform (by Symbian Foundation)
 - Embedded Linux
 - Android (by Open Handset Alliance)
 - Microsoft Windows CE, Pocket PC, Pocket PC Phone Edition, Mobile
 - Microsoft Windows Phone / 10 Mobile
 - Firefox OS
 - KaiOS
 - HarmonyOS
- Threats, attacks and countermeasures
 - Threats and attacks
 - Countermeasures



- Launched in October and November 2010
- Successor to Windows Mobile platform, but **technically a new and different platform without backward compatibility**
- Aimed at consumer market instead of enterprise market unlike Windows Mobile
- New user interface

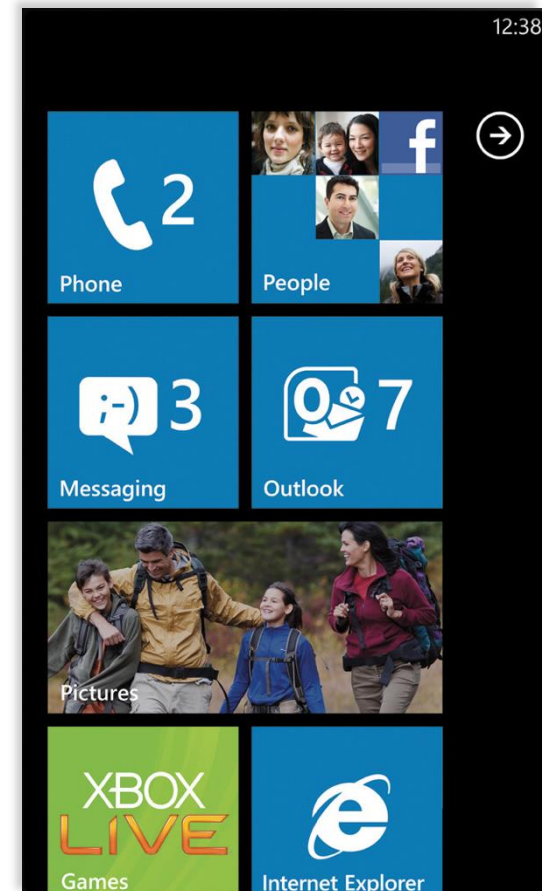

Windows Phone

- Windows Phone 8 launched in October 2012 together with Windows 8 with similar optics
- Successor to Windows Phone 7
- Latest release: Windows Phone 8.1 in April 2014



- Windows 10 Mobile Insider Preview available in July 2015
- November 2015: Supported phones include HTC One (M8) and 36 Lumia models.
- Other eligible Windows Phone devices can receive updates since March 2016.
- Discontinued (last security update in January 2020)





- The market for mobile devices and mobile OS
- Mobile OS unavailable to other device manufacturers
 - Overview
 - Palm OS
 - Apple iOS (Unix-based)
- Manufacturer-independent mobile OS
 - Overview
 - Symbian platform (by Symbian Foundation)
 - Embedded Linux
 - Android (by Open Handset Alliance)
 - Microsoft Windows CE, Pocket PC, Pocket PC Phone Edition, Mobile
 - Microsoft Windows Phone / 10 Mobile
 - Firefox OS
 - KaiOS
 - HarmonyOS
- Threats, attacks and countermeasures
 - Threats and attacks
 - Countermeasures

- Linux-based open-source mobile OS for smartphones and tablet computers
- Originally developed by **Mozilla**, a non-profit organization known for the Firefox web browser
- Focus on open standards, e.g. HTML5 applications
- 2012-02: Firefox OS first publicly demonstrated
- 2013-07: First commercial Firefox OS based phones launched:
 - *ZTE Open* in Spain by Telefónica
 - *Alcatel One Touch Fire* in Poland by Deutsche Telekom (also sold in Germany by subsidiary *Congstar*)
 - *LG Fireweb* in Brazil by Telefónica brand *Vivo*
- Mozilla expressed strong position on **user privacy**
 - Upon installation of applications, a reason is stated why certain rights are necessary and need to be granted by the user.
 - User data will be analysed locally on the device, not transferred to servers, exploited or traded.
- 2015-12: Mozilla announced to stop offering smartphones through mobile operator channels.
 - Possible pick-up: H5OS by Acadine Technologies
- 2016-09: Mozilla work on Firefox OS ceased
- Latest release: 2.2.0 (2015-08)
- Latest developer version: 2.6.0 (2015-10)
- Forked to form KaiOS

Firefox OS



- The market for mobile devices and mobile OS
- Mobile OS unavailable to other device manufacturers
 - Overview
 - Palm OS
 - Apple iOS (Unix-based)
- Manufacturer-independent mobile OS
 - Overview
 - Symbian platform (by Symbian Foundation)
 - Embedded Linux
 - Android (by Open Handset Alliance)
 - Microsoft Windows CE, Pocket PC, Pocket PC Phone Edition, Mobile
 - Microsoft Windows Phone / 10 Mobile
 - Firefox OS
 - KaiOS
 - HarmonyOS
- Threats, attacks and countermeasures
 - Threats and attacks
 - Countermeasures

- A mobile OS based on Linux
- Owned by KaiOS Technologies, a US-based company
- Forked from B2G (Boot to Gecko), an open source community-driven successor of Firefox OS
- 2017: Initial release
- 2018: Google invested US \$ 22 million in the OS. India-based telecom operator Reliance Jio also invested \$ 7 million in cash to pick up a 16% stake.
- KaiOS beat Apple's iOS for second place in India, while Android dominates with 71%:
 - Largely attributed to popularity of the competitively-priced Jio Phone.
 - In Q1 2018, 23 million KaiOS devices were shipped in Asia, Africa, Middle East, Latin America, and North America.

KaiOS



- KaiOS supports:
 - 4G LTE E, VoLTE, GPS and Wi-Fi with HTML5-based apps
 - A dedicated app marketplace called KaiStore enables users to download applications.
 - Lightweight hardware resource usage: able to run on devices with just 256 MB of memory.
- Latest release: 3.1 (March 2022)



- The market for mobile devices and mobile OS
- Mobile OS unavailable to other device manufacturers
 - Overview
 - Palm OS
 - Apple iOS (Unix-based)
- Manufacturer-independent mobile OS
 - Overview
 - Symbian platform (by Symbian Foundation)
 - Embedded Linux
 - Android (by Open Handset Alliance)
 - Microsoft Windows CE, Pocket PC, Pocket PC Phone Edition, Mobile
 - Microsoft Windows Phone / 10 Mobile
 - Firefox OS
 - KaiOS
 - HarmonyOS
- Threats, attacks and countermeasures
 - Threats and attacks
 - Countermeasures

HarmonyOS (Hongmeng OS)



- Launched August 2019
- Initially developed for Huawei smart TVs
- Conflict with the U.S.: more platforms in planning for HarmonyOS 2.0
 - HarmonyOS 2.0 will support devices with up to 128 MB RAM, such as smart wearables and other IoT devices
 - 2021: support devices up to 4 GB RAM, such as tablets and entry-level smartphones
 - End of 2021: RAM limit will increase over 4 GB to support more powerful smartphones
- Latest Updates:
 - Latest release: 4.2 (April 11 2024)

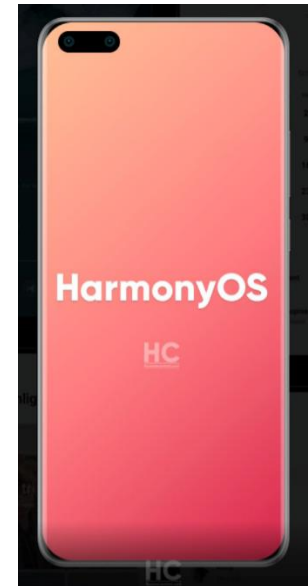

- The market for mobile devices and mobile OS
- Mobile OS unavailable to other device manufacturers
 - Overview
 - Palm OS
 - Apple iOS (Unix-based)
- Manufacturer-independent mobile OS
 - Overview
 - Symbian platform (by Symbian Foundation)
 - Embedded Linux
 - Android (by Open Handset Alliance)
 - Microsoft Windows CE, Pocket PC, Pocket PC Phone Edition, Mobile
 - Microsoft Windows Phone / 10 Mobile
 - Firefox OS
 - KaiOS
 - HarmonyOS
- Threats, attacks and countermeasures
 - Threats and attacks
 - Countermeasures

- Many mobile operating systems allow the execution of 3rd-party software:
 - Malware can be executed on mobile operating systems, either intentionally or by security leaks inside the mobile operating system (exploits).
- Possible threats for the user are:
 - Device malfunction
 - Loss of data (malware erasing data)
 - Loss of money (e.g. malware sending SMS to premium services)
 - Shorter battery runtime (more processing/resource usage)

Beginnings of mobile malware

- **09/2000:** Liberty Horse Trojan
- **12/2000:** Telefonica SMS Mailer
- **08/2001:** Flooder sends unwanted SMS
- **09/2001:** Phage erases data on Palm devices
- **02/2003:** Nokia V-Card exploit
- **09/2004:** First Symbian OS malware
- ...

Strong growth of mobile malware

- The number of malware programs masquerading as legitimate mobile apps grew by more than 600 percent in 2012
- Most popular target: Android



[ATD2013]



[Sophos2016]

Timeline mobile threats 2004-2011

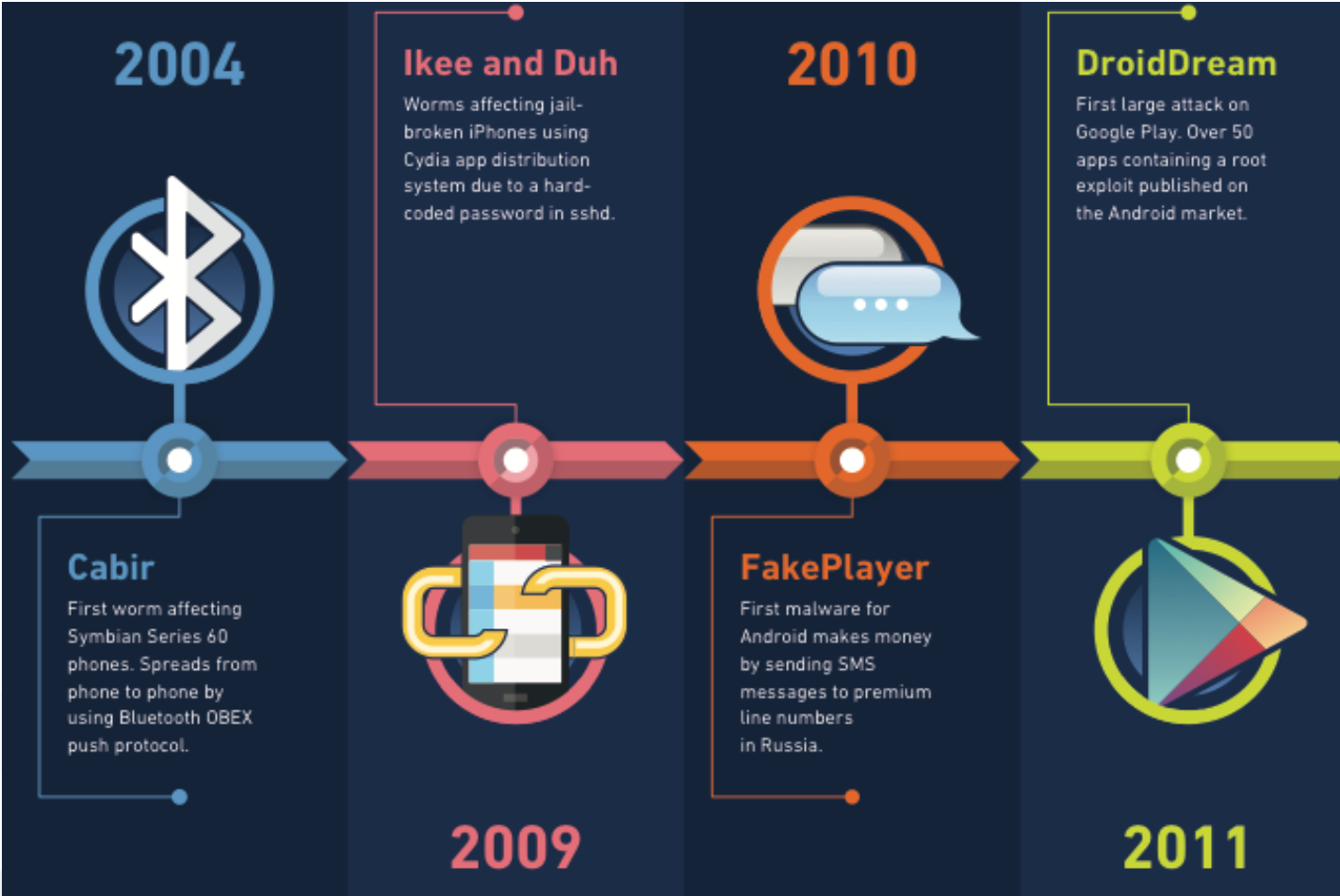

Timeline mobile threats 2012-2016

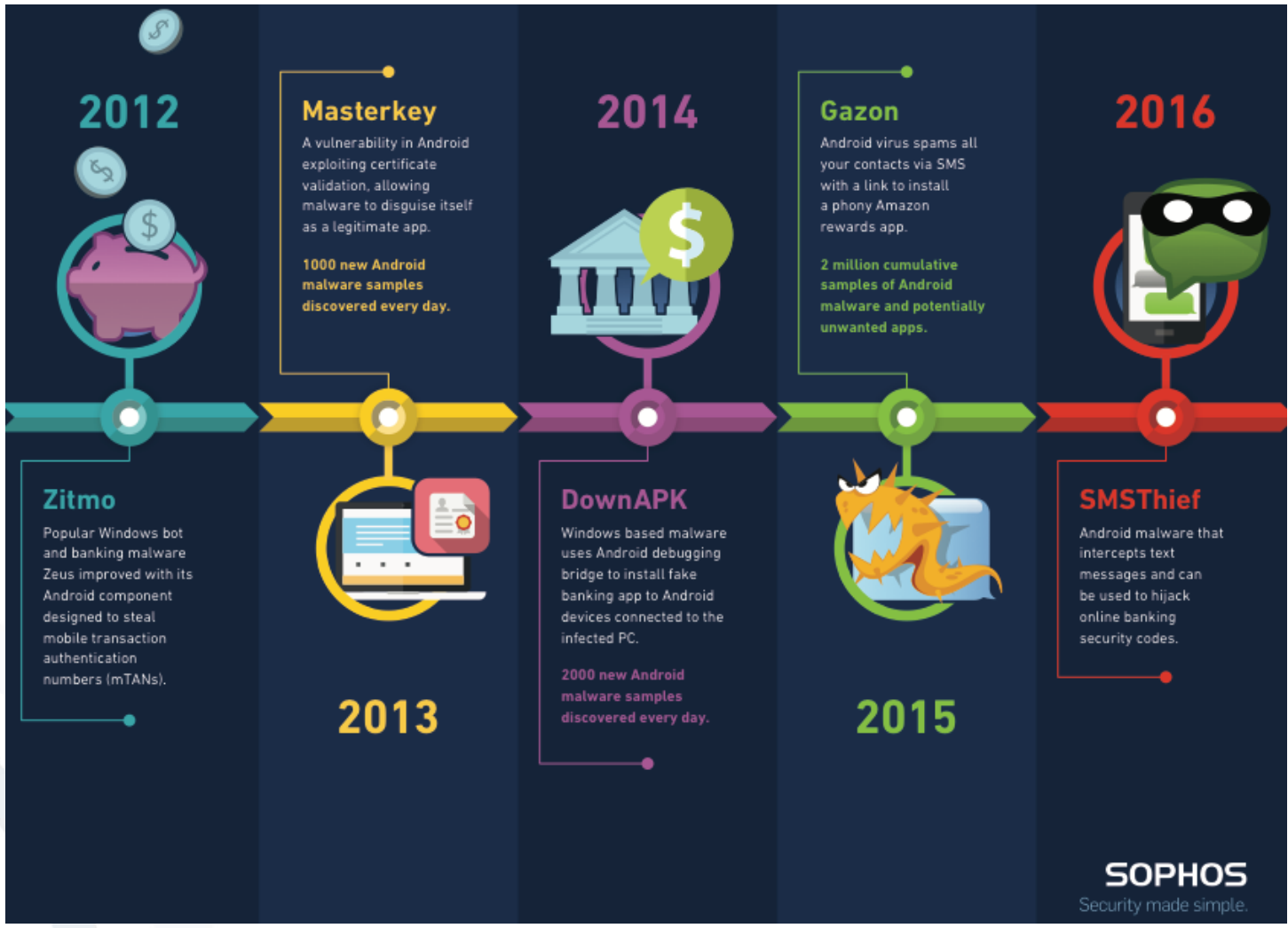

Mobile threats in numbers

New mobile malware families

The number of new mobile malware families increased by 12.2 percent between 2016 and 2017.

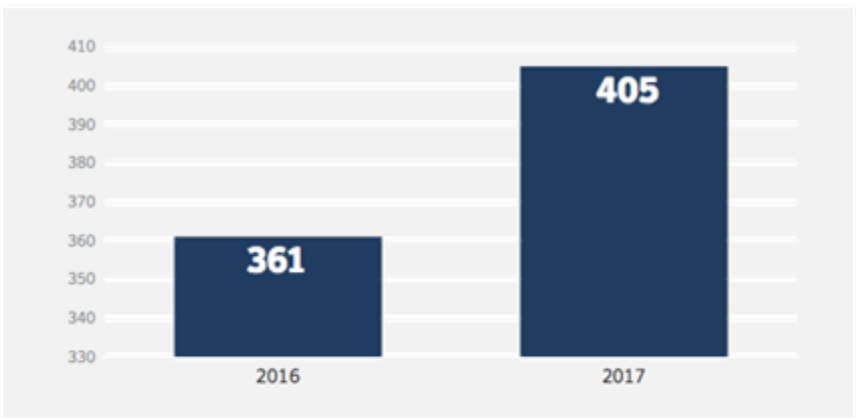

New mobile grayware families

The number of new mobile grayware families grew by 5.3 percent in 2017.

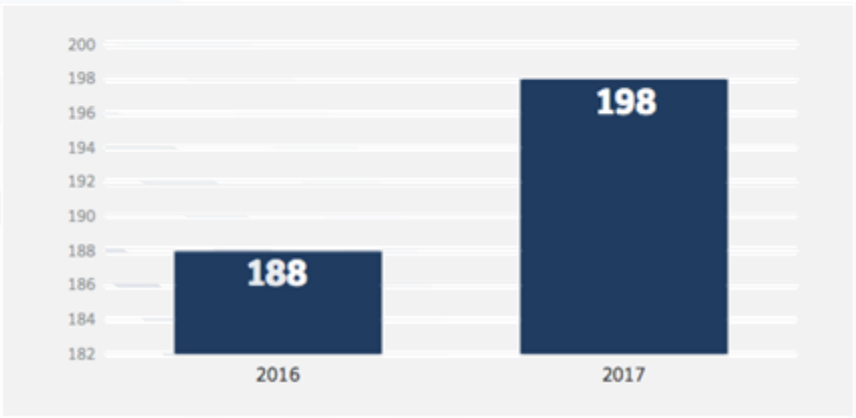

Top countries for mobile malware

Top 10 list of countries where mobile malware was most frequently blocked in 2017.

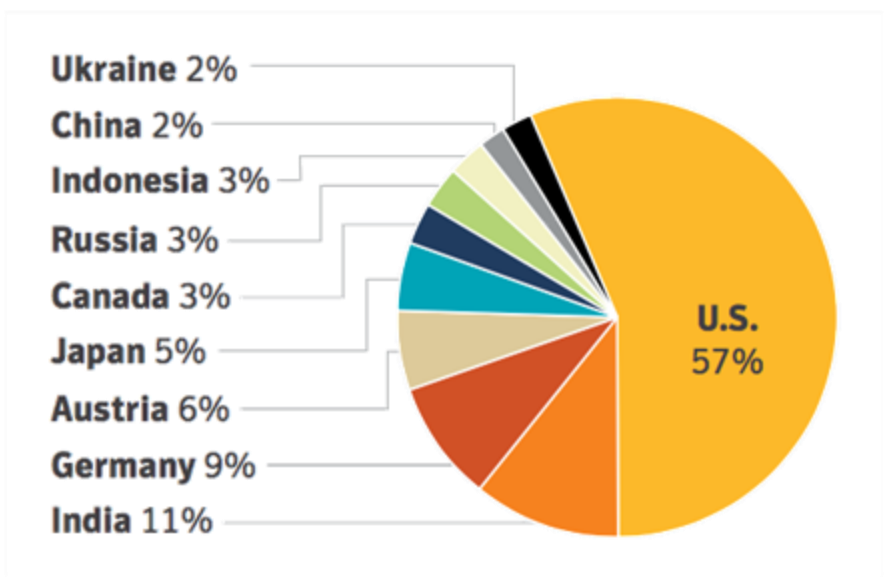

Distribution of newly detected mobile malware by type

Q2 and Q3 2023

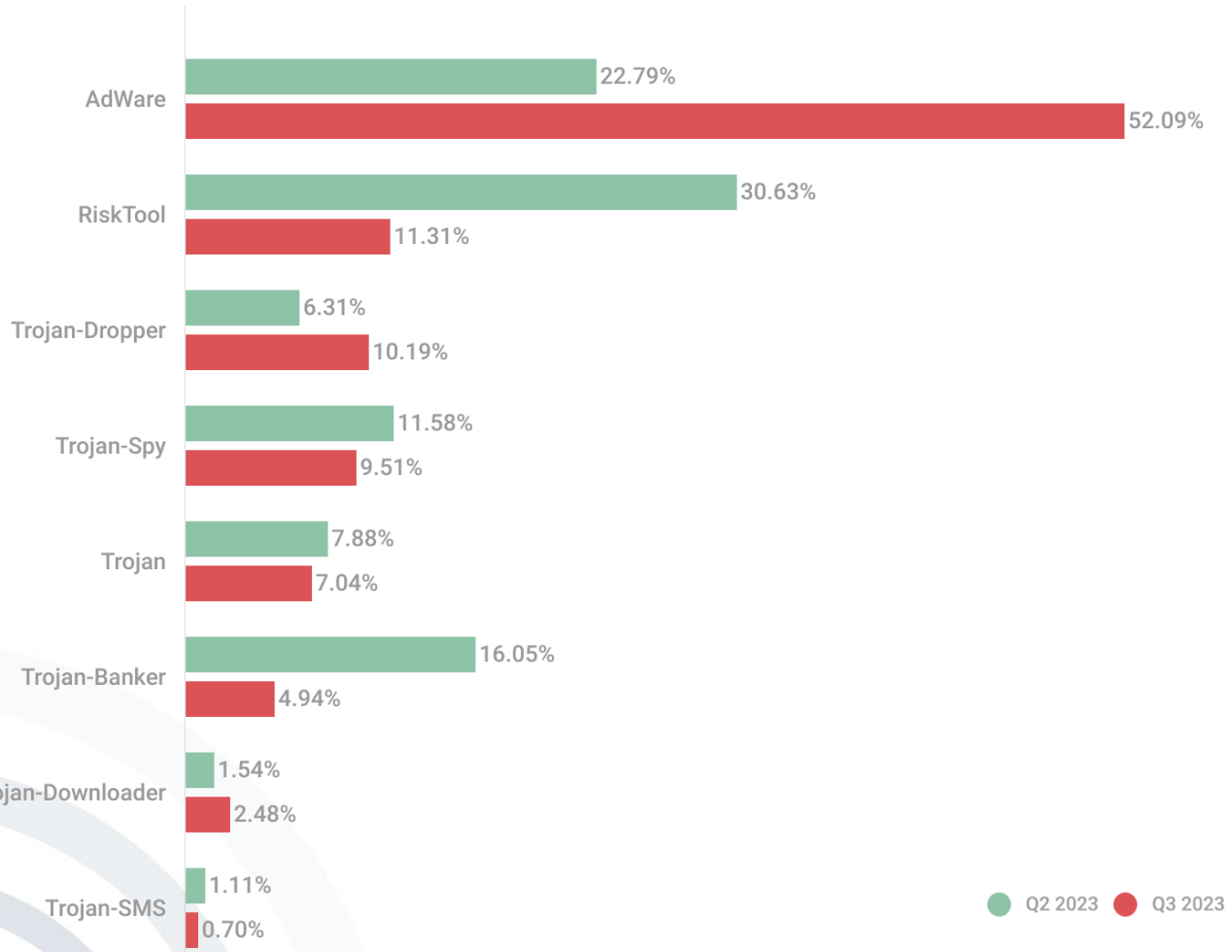

- Attacks are becoming commercial services for “customers” (e.g. for distributed-denial-of-service).
- Mobile devices may get „recruited“ for executing attacks.
- States attack mobile devices upfront (e.g. FBI vs. Apple).
- Apps and security software are major attack vectors.

- A one-week behaviour analysis of top 10 Android fitness apps revealed:
 - The apps accessed sensitive data while users were not interacting with devices.
 - They transmitted sensitive data to remote servers without users' knowledge.
 - Transferring data to outside EU (GDPR issue)
 - Promises did not match actions (privacy policies vs. real behaviour).

- The market for mobile devices and mobile OS
- Mobile OS unavailable to other device manufacturers
 - Overview
 - Palm OS
 - Apple iOS (Unix-based)
- Manufacturer-independent mobile OS
 - Overview
 - Symbian platform (by Symbian Foundation)
 - Embedded Linux
 - Android (by Open Handset Alliance)
 - Microsoft Windows CE, Pocket PC, Pocket PC Phone Edition, Mobile
 - Microsoft Windows Phone / 10 Mobile
 - Firefox OS
 - KaiOS
 - HarmonyOS
- Threats, attacks and countermeasures
 - Threats and attacks
 - Countermeasures

- A3: Android App Behaviour Analyser

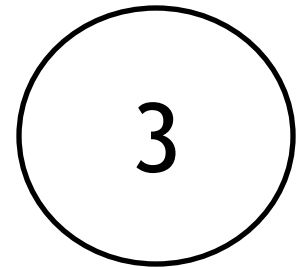
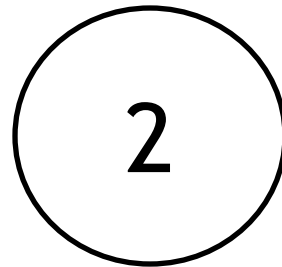
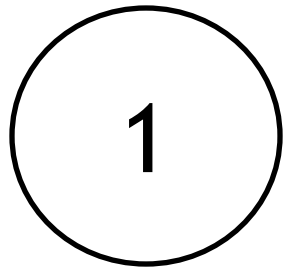

Responsible for
monitoring apps'
behaviour

Analysing
potential
privacy risks

Risk
communication
to users

A3: Android App Behaviour Analyser

The screenshots show the following screens:

- List of suspicious apps (11:19):** A list of 15 apps with their permission counts and warning icons. Apps include AccuWeather (2 permissions), Always On Display (1 permission), Android system (4 permissions), Autofill with Samsung Pass (1 permission), BadgeProvider (1 permission), Contacts Storage (3 permissions), Device maintenance (1 permission), DQA (1 permission), Facebook (5 permissions), Game Optimizing Service (1 permission), Gmail (2 permissions), Google (2 permissions), and Google Play services (4 permissions).
- List of suspicious apps (11:20):** The same list as above, but with a 'REPORT' button below the app list and a list of permissions with checkboxes: 9x Access to coarse location information, 4x Access to fine location information, 1x Allows an application to access notifications, and 1x Allows an application to read the user's contacts data.
- Scan Options (11:21):** Configuration options for scanning: Scan Duration (Default), Scan Interval (5 Seconds), Delete Older Scans (Default), and Wifi only (toggle off).
- Report (16:03):** A detailed report of access events for coarse location information, including timestamps and status (e.g., 'Access to coarse location information. 14:38:55. No anomalous access at that time'). It includes a section for providing an explanation and buttons for 'CANCEL' and 'REPORT'.

- ESARA: A Framework for Enterprise Smartphone Apps Risk Assessment

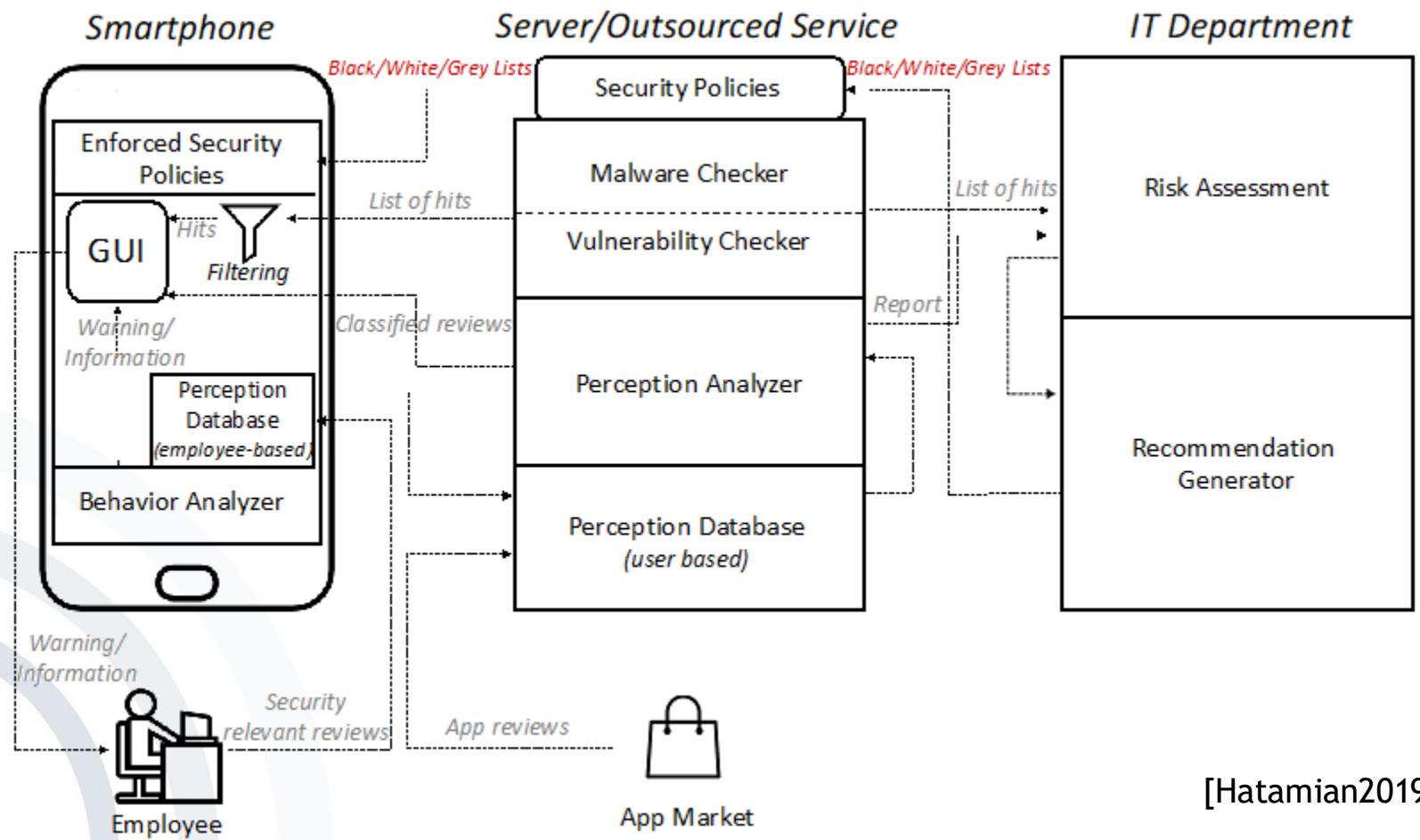

- Memory protection
 - Processes are not able to access the memory of other processes.
- File protection
 - Encryption
 - Access control
- Access controls
 - Definition of access rights and monitoring of their enforcement.
- Support for security modules
- Secure I/O
- Code integrity management: Integrity of programs is checked before they are started by e.g.
 - Checking certificates
 - Proof Carrying Code
- Additional security software may be needed, e.g.
 - Virus scanners
 - Firewalls

- Every user has certain assigned access rights, e.g.
 - Reading a file
 - Writing a file
 - Accessing a peripheral device
- The OS controls that users or the processes started by a user, can only execute those actions, which they are allowed to.

<i>Object</i> <i>User</i>	<i>File 1</i>	<i>File 2</i>	<i>File 3</i>	<i>Device's periphery</i>
<i>U1</i>	Read		Read	
<i>U2</i>				Print
<i>U3</i>		Read	Execute	
<i>U4</i>	Read Write		Read Write	

- [ATD2013] Juniper Study Finds Mobile Malware Grew 600 Percent, Targets Android Most, <http://allthingsd.com/20130626/juniper-study-finds-mobile-malware-grew-600-percent-targets-android-most/>, accessed 2013-11-26.
- [Gartner2015] Gartner Group (2015), Gartner Says Worldwide Smartphone Sales Recorded Slowest Growth Rate Since 2013, <https://www.gartner.com/newsroom/id/3115517>, accessed 2015-11-06
- [Gartner2016] Gartner Group (2016), Gartner Says Five of Top 10 Worldwide Mobile Phone Vendors Increased Sales in Second Quarter of 2016 <http://www.gartner.com/newsroom/id/3415117>, accessed 2016-12-12
- [Gartner2017] Gartner Group (2017), Gartner Says Demand for 4G Smartphones in Emerging Markets Spurred Growth in Second Quarter of 2017 <https://www.gartner.com/newsroom/id/3788963>
- [Hpcfactor2010] www.hpcfactor.com/support/windowsce, accessed 2014-09-03.
http://commons.wikimedia.org/wiki/File:Windows_CE_Timeline.png, accessed 2014-09-03.
- [Hatamian2019-1] M. Hatamian, N. Momen, L. Fritsch, and K. Rannenber. 2019. "A Multilateral Privacy Impact Analysis Method for Android Apps", APF 2019
- [Hatamian2017-2] M. Hatamian, J. Serna-Olvera, K. Rannenber, and B. Igler, FAIR: Fuzzy Alarming Index Rule for Privacy Analysis in Smartphone Apps, TrustBus 2017
- [Hatamian2019-3] M. Hatamian, S. Paper, and K. Rannenber. 2019. "ESARA: A Framework for Enterprise Smartphone Apps Risk Assessment, IFIP SEC 2019
- [Macrumors2022] <https://www.macrumors.com/2022/04/22/ios-grows-mobile-market-share/>, accessed 08.12.2022
- [Nielsen 2013] Who's Winning the U.S. Smartphone Market?, <http://www.nielsen.com/us/en/newswire/2013/whos-winning-the-u-s-smartphone-market-.html>, accessed 2013-11-22

- [Nokia2013] Nokia Developer News: Changes to supported content types in the Nokia Store, <http://developer.nokia.com/Blogs/News/blog/2013/10/04/changes-to-supported-content-types-in-the-nokia-store/>, accessed 2013-11-26.
- [Sophos2015] Sophos, Malware Goes Mobile: Timeline of Mobile Threats, 2004-2015, <https://www.sophos.com/en-us/medialibrary/PDFs/other/sophos-mobile-malware-timeline-infographic.pdf>, accessed 2015-11-05.
- [Securelist2022] <https://securelist.com/it-threat-evolution-in-q1-2022-mobile-statistics/106589/>
- [Securelist2023] <https://securelist.com/it-threat-evolution-q3-2023-mobile-statistics/111224/> (accessed: 2023-12-14)
- [Statcounter2022] <https://gs.statcounter.com/os-market-share/mobile/worldwide/#monthly-201201-202212>, accessed 15.12.2022
- [Statcounter2023] <https://gs.statcounter.com/os-market-share/mobile/worldwide/#quarterly-200901-202302> (accessed 16.10.2023)
- [Statista2014a] <http://de.statista.com/statistik/daten/studie/73662/umfrage/marktanteil-der-smartphone-betriebssysteme-nach-quartalen/>, accessed 2014-10-07.
- [Statista2014b] <http://de.statista.com/statistik/daten/studie/77324/umfrage/marktanteile-der-betriebssysteme-fuer-smartphones-in-den-usa/>, accessed 2014-10-07.
- [Statista2014c] <http://de.statista.com/statistik/daten/studie/173056/umfrage/weltweite-marktanteile-der-smartphone-hersteller-seit-4-quartal-2009/>, accessed 2014-10-07.
- [Statista2014d] <http://de.statista.com/statistik/daten/studie/173048/umfrage/weltweiter-absatz-der-smartphone-hersteller-nach-quartalen/>, accessed 2014-10-07.
- [Statista2015] Marktanteile der führenden Betriebssysteme am Absatz von Smartphones weltweit vom 1. Quartal 2009 bis zum 3. Quartal 2016, <http://de.statista.com/statistik/daten/studie/73662/umfrage/marktanteil-der-smartphone-betriebssysteme-nach-quartalen/>, accessed 2015-11-05.

- [Statista2015a] Marktanteile der Betriebssysteme an der Smartphone-Nutzung in den USA von Januar 2011 bis Juli 2015.
<http://de.statista.com/statistik/daten/studie/77324/umfrage/marktanteile-der-betriebssysteme-fuer-smartphones-in-den-usa/>, accessed 2015-11-05.
- [Statista2016a] Marktanteile der führenden Betriebssysteme am Absatz von Smartphones weltweit vom 1. Quartal 2009 bis zum 3. Quartal 2016.
<https://de.statista.com/statistik/daten/studie/73662/umfrage/marktanteil-der-smartphone-betriebssysteme-nach-quartalen/>
- [Statista2016b] Global smartphone sales to end users from 1st quarter 2009 to 3rd quarter 2016, by operating system (in million units).
- [Statista2016c] Marktanteile der Betriebssysteme an der Smartphone-Nutzung in den USA von Januar 2011 bis Oktober 2016.
- [Statista2017b] Marktanteile der Betriebssysteme an der Smartphone-Nutzung in den USA von Januar 2011 bis Juni 2017
- [Statista2022] <https://www.statista.com/statistics/272698/global-market-share-held-by-mobile-operating-systems-since-2009/> accessed 08.12.2022

- [Symantec2018] Symantec, ISTR - Internet Security Threat Report, 2018.
- [Symbian2006] symbianblogs.com/history.html, accessed 2011-09-20.
- [Wiki2016] Wikipedia, Comparison of mobile operating systems.
https://en.wikipedia.org/wiki/Comparison_of_mobile_operating_systems Accessed 2016-12-12.